



EN User Manual | **Oven**

BPE748380T

BPK748380B

BPK748380M

BPK748380T

INSTALLATION

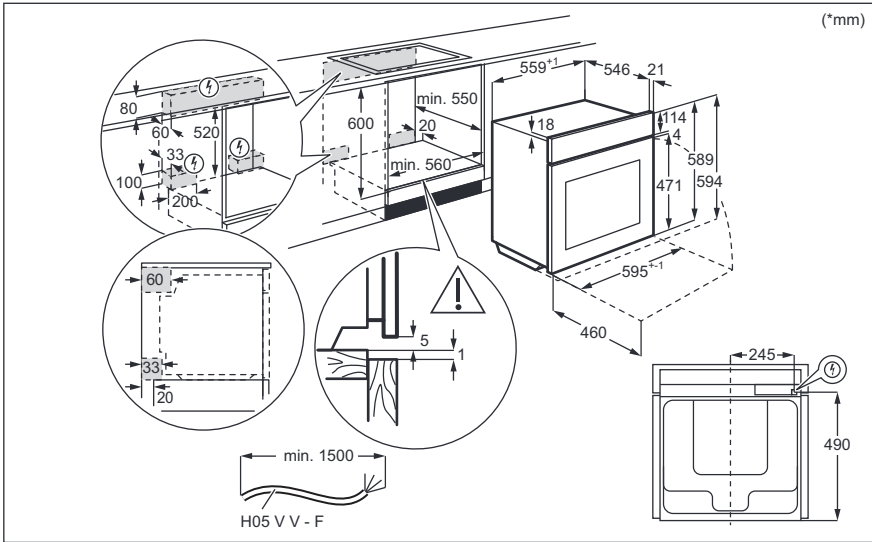
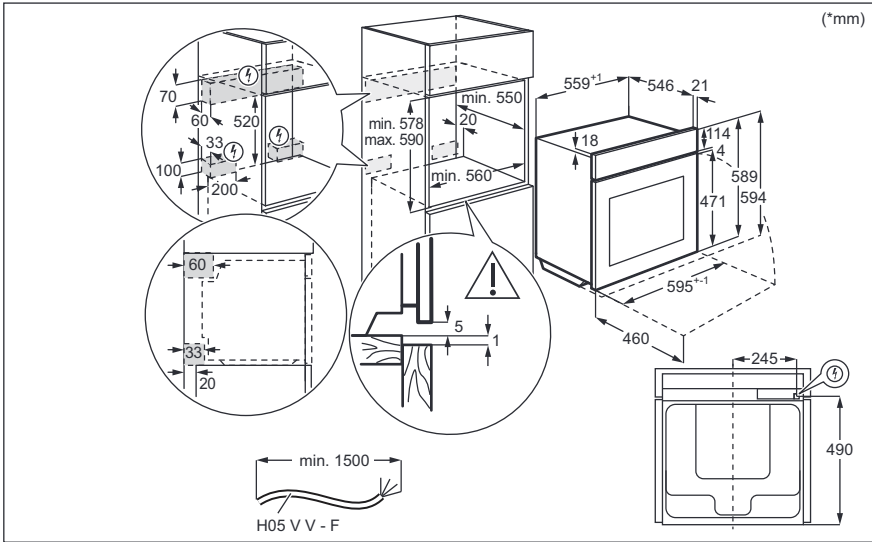

Welcome to AEG! Thank you for choosing our appliance.



In our drive to be sustainable, we are reducing paper assets and provide full user manuals online. Access your full user manual at aeg.com/manuals



Get usage advice, brochures, trouble shooter, service and repair information at aeg.com/support



For more recipes, hints, troubleshooting download **My AEG Kitchen** app.



1. ⚠ SAFETY INFORMATION

Before the installation and use of the appliance, carefully read the supplied instructions. The manufacturer is not responsible for any injuries or damage that are the result of incorrect installation or usage. Always keep the instructions in a safe and accessible location for future reference.

- This appliance can be used by children aged from 8 years and above and persons with reduced physical, sensory or mental capabilities or lack of experience and knowledge if they have been given supervision or instruction concerning the use of the product in a safe way and understand the hazards involved. Children of less than 8 years of age and persons with very extensive and complex disabilities shall be kept away from the appliance unless continuously supervised.
- Children should be supervised to ensure that they do not play with the appliance and mobile devices with My Electrolux Kitchen / My AEG Kitchen (if applicable).
- Keep all packaging away from children and dispose of it appropriately.
- **WARNING:** Keep children and pets away from the appliance when it operates or when it cools down. Accessible parts become hot.
- Children shall not carry out cleaning and user maintenance of the appliance without supervision.
- If the appliance has a child safety device, it should be activated.
- This appliance is for cooking purposes only.
- This appliance is designed for single household domestic use in an indoor environment.
- This appliance may be used in, offices, hotel guest rooms, bed & breakfast guest rooms, farm guest houses and other similar accommodation where such use does not exceed (average) domestic usage levels.

- **WARNING:** The appliance and its accessible parts become hot during use. Care should be taken to avoid touching heating elements.
- Always use oven gloves to remove or put in accessories or ovenware.
- Always cook with the oven door closed.
- To remove the shelf supports first pull the front of the shelf support and then the rear end away from the side walls. Install the shelf supports in the opposite sequence (if applicable).
- Do not use a steam cleaner to clean the appliance.
- Do not use harsh abrasive cleaners or sharp metal scrapers to clean the glass door since they can scratch the surface, which may result in shattering of the glass.
- **WARNING:** Ensure that the appliance is switched off before replacing the lamp to avoid the possibility of electric shock.
- Use only the food sensor (core temperature sensor) recommended for this appliance (if applicable).
- Remove all accessories and excessive spillage from the appliance before the pyrolytic cleaning.

2. SAFETY INSTRUCTIONS

2.1 Installation and Electrical connection

 **WARNING!**

Only a qualified person must install and connect this appliance.

Follow the installation instructions supplied with the appliance.

Install the appliance in a safe and suitable place that meets installation requirements.

Do not use the appliance before installing it in the built-in structure.

Keep the minimum distance from other appliances and units. Before mounting the appliance, check if the oven door opens without restraint.

Do not install or use a damaged appliance.

Remove all the packaging.

Always take care when moving the appliance as it is heavy. Do not pull the appliance by the handle. Always use safety gloves and enclosed footwear.

The appliance is equipped with an electric cooling system. It must be operated with the electric power supply.

 **WARNING!**

Risk of fire and electric shock.

Make sure that the parameters on the rating plate are compatible with the electrical ratings of the mains power supply.

The appliance must be earthed. Always use a correctly installed shockproof socket.

Do not use multi-plug adapters and extension cables.

This appliance is supplied without a main plug and a main cable.

Do not let mains cables touch or come near the appliance door or the niche below the appliance, especially when it operates or the door is hot.

Use only correct isolation devices: line protecting cut-outs, fuses (screw type fuses removed from the holder), earth leakage trips and contactors.

The electrical installation must have an isolation device which lets you disconnect the appliance from the mains at all poles. The isolation device must have a contact opening width of minimum 3 mm.

For the section of the cable refer to the total power on the rating plate. You can also refer to the table:

Cable types applicable for installation or replacement for Europe:

H07 RN-F, H05 RN-F, H05 RRF, H05 VV-F, H05 V2V2-F (T90), H05 BB-F

Total power (W)	Section of the cable (mm ²)
maximum 1380	3 x 0.75
maximum 2300	3 x 1
maximum 3680	3 x 1.5

2.2 Use and Maintenance

 **WARNING!**

Risk of injury, burns, electric shock, fire, explosion or damage to the appliance.

Do not change the specification of this appliance.

Do not let the appliance stay unattended during operation. Deactivate the appliance after each use.

Make sure that the ventilation openings are not blocked.

If the appliance is installed behind a furniture panel (e.g. a door) make sure the door is never closed when the appliance operates. Heat and moisture can build up behind a closed furniture panel and cause subsequent damage to the appliance, the furniture or the floor. Do not close the furniture panel until the appliance has cooled down after use.

Be careful when you open the appliance door while the appliance is in operation. Hot air can release.

Do not operate the appliance with wet hands or when it has contact with water.

Do not apply pressure on the open door. Be careful when you remove the door from the appliance. The door is heavy.

Do not use the appliance as a work surface or as a storage surface.

Do not put flammable products or items that are wet with flammable products in, near or on the appliance.

When you place food into hot oil, it may splash.

Open the appliance door carefully. The use of ingredients with alcohol can cause a mixture of alcohol and air.

Do not let sparks or open flames to come in contact with the appliance when you open the door.

Do not share your Wi-Fi password (if applicable).

To prevent damage or discoloration to the enamel:

- do not put ovenware or other objects in the appliance directly on the bottom.
- do not put aluminium foil directly on the bottom of cavity of the appliance.
- do not put water directly into the hot appliance.
- do not keep moist dishes and food in the appliance after you finish the cooking.
- be careful when you remove or install the accessories.

Use a deep pan for moist cakes. Fruit juices cause stains that can be permanent.

Discoloration of the enamel or stainless steel has no effect on the performance of the appliance.

Clean regularly the appliance to prevent the deterioration of the surface material.

Before maintenance, deactivate the appliance and disconnect from the mains. Do not clean the catalytic enamel (if applicable) with detergents.

Make sure the appliance is cold. There is the risk that the glass panels can break. Replace immediately the door glass panels when they are damaged. Contact the Authorised Service Centre.

Clean the appliance with a moist soft cloth. Use only neutral detergents. Do not use abrasive products, abrasive cleaning pads, solvents or metal objects.

Do not clean the catalytic enamel with detergents (if applicable).

If you use an oven spray, follow the safety instructions on its packaging.

Concerning the lamp(s) inside this product and spare part lamps sold separately: These lamps are intended to withstand extreme physical conditions in household appliances, such as temperature, vibration, humidity, or are intended to signal information about the operational status of the appliance. They are not intended to be used in other applications and are not suitable for household room illumination.

Use only lamps with the same specifications.

This product contains a light source of energy efficiency class G.

To repair the appliance contact the Authorised Service Centre. Use original spare parts only.

2.3 Pyrolytic cleaning

WARNING!

Risk of Injury / Fires / Chemical Emissions (Fumes) in Pyrolytic Mode. Do not start the Pyrolysis if the Plus Steam button is pressed in (if applicable).

Before carrying out the pyrolytic cleaning and initial preheating remove from the oven cavity:

- any excess food residues, oil or grease spills / deposits.
- any removable objects (including shelves, side rails etc., provided with the product) particularly any non-stick pots, pans, trays, utensils etc.

Pyrolytic cleaning is a high temperature operation that can release fumes from cooking residues and construction materials, as such consumers are advised to:

- provide good ventilation during and after each pyrolytic cleaning.
- provide good ventilation during and after the first use at maximum temperature operation.

If there are other appliances installed in the same cabinet, do not use them at the same time as the pyrolytic cleaning. It can cause damage to the oven.

Fumes released from all pyrolytic ovens / cooking residues as described are not harmful to humans, including children, or persons with medical conditions.

Keep away small pets from the appliance during and after the pyrolytic cleaning and initial preheating. Birds and reptiles can be highly sensitive to the temperature changes and emitted fumes.

Non-stick surfaces on pots, pans, trays, utensils etc., can be damaged by the high temperature pyrolytic cleaning operation of all pyrolytic ovens and can be also a source for low level harmful fumes.

2.4 Disposal

WARNING!

Risk of injury or suffocation.

Disconnect the appliance from the mains supply. Cut off the mains electrical cable close to the appliance and dispose of it.

Remove the door catch to prevent children or pets from becoming trapped in the appliance.

3. PRODUCT DESCRIPTION

3.1 General overview

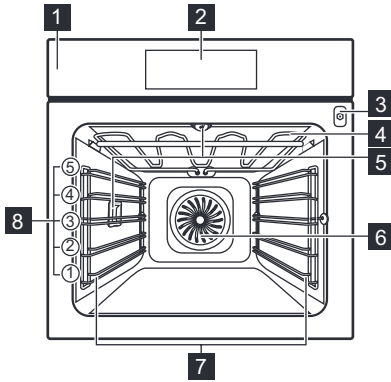

- 1 Control panel
- 2 Display
- 3 Socket for the food sensor
- 4 Heating element
- 5 Lamp
- 6 Fan
- 7 Shelf support, removable
- 8 Shelf positions

4. CONTROL PANEL

4.1 Control panel overview

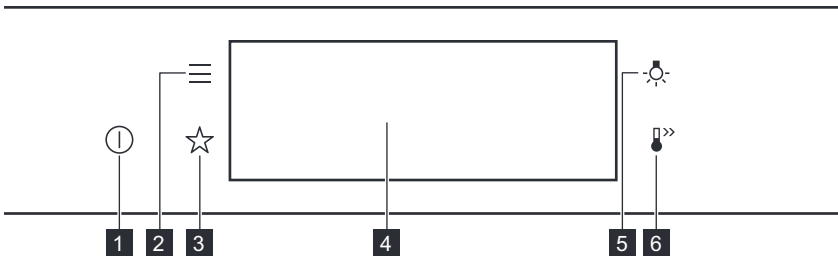

1	ON / OFF	Press and hold to turn the appliance on and off.
2	Menu	Lists the appliance functions.
3	Favourites	Lists the favourite settings.
4	Display	Shows the current settings of the appliance.
5	Lamp switch	To turn the lamp on and off.
6	Fast Heat Up	To turn on and off the function: Fast Heat Up.

4.2 Display

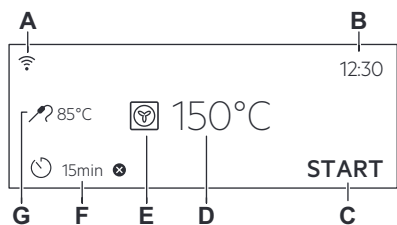

Display with key functions set.

- A. Wi-Fi
- B. Time of day
- C. START/STOP
- D. Temperature
- E. Heating functions
- F. Timer
- G. Food sensor (selected models only)

Display indicators

Basic indicators - to navigate on the display.



To confirm the selection / setting.



To go one level back in the menu.



To undo the last action.



To turn the options on and off.

Sound alarm function indicators - when the set time of cooking ends, the signal sounds.



The function is on.



The function is on.
Cooking stops automatically.



Sound alarm is off.

Timer indicators



To set the function: Delayed start.



To cancel the setting.

Wi-Fi indicator - the appliance can be connected to Wi-Fi.



Wi-Fi connection is turned on.

Remote operation indicator - the appliance can be controlled remotely.



Remote operation is turned on.

5. BEFORE FIRST USE

5.1 Initial Cleaning



Step 1



Step 2



Step 3

Remove all accessories and removable shelf supports from the appliance.

Clean the appliance and the accessories only with a microfibre cloth, warm water and a mild detergent.

Place the accessories and the removable shelf supports in the appliance.

5.2 First connection

The display shows welcome message after the first connection.

You have to set: Language, Display brightness, Key tones, Buzzer volume, Time of day.

5.3 Wireless connection

To connect the appliance you need:

- Wireless network with the Internet connection.
- Mobile device connected to the same wireless network.

Step 1 To download My AEG Kitchen app: Scan the QR code on the rating plate with the camera on your mobile device to be redirected to AEG Homepage. The rating plate is on the front frame of the appliance cavity. You can also download the app directly from the app store.

Step 2 Follow the app onboarding instructions.

Step 3 Turn on the appliance.

Step 4 Press: . Select: Settings / Connections.

Step 5  - slide or press to turn on: Wi-Fi.

Step 6 The appliance wireless module starts within 90 sec.

Frequency	2.4 GHz WLAN
-----------	--------------

2400 - 2483.5 MHz

Protocol	IEEE 802.11b DSSS, 802.11g/n OFDM
----------	-----------------------------------

Max Power	EIRP < 20 dBm (100 mW)
-----------	------------------------

Wi-Fi module	NIUS-50
--------------	---------

United Kingdom is covered by the provision of UK SI 2017, No 1206: Radio Equipment Regulations.

5.4 Software licences

The software in this product contains components that are based on free and open source software. AEG acknowledges the contributions of the open software and robotics communities to the development project.

To access the source code of these free and open source software components whose

license conditions require publishing, and to see their full copyright information and applicable license terms, visit: <http://aeg.opensoftwarerepository.com> (folder NIUS).

5.5 Initial preheating

Preheat the empty oven before the first use.

Step 1 Remove all accessories and removable shelf supports from the oven.

Step 2 Set the maximum temperature for the function: 
Let the oven operate for 1 h.

Step 3 Set the maximum temperature for the function: 
Let the oven operate for 15 min.

 The oven can emit an odour and smoke during preheating. Make sure that the room is ventilated.

6. DAILY USE

6.1 How to set: Heating functions

Step 1 Turn on the oven. The display shows the default heating function.

Step 2 Press the symbol of the heating function  to enter the submenu.

Step 3 Select the heating function and press: **OK**. The display shows: temperature.

Step 4 Set: temperature. Press: **OK**.

Step 5 Press: **START** .
Food Sensor - you can plug the sensor at any time before or during cooking.

STOP - press to turn off the heating function.

Step 6 Turn off the oven.

6.2 How to set: Assisted Cooking

Step 1 Turn on the oven.

Step 2 Press: 



Step 3 Press:  . Enter: Assisted Cooking.



Step 4 Choose a dish or a food type.





Step 5 Press: **START** .

6.3 Heating functions







STANDARD



Heating function	Application
	Grill: Toasting, grilling
	Turbo Grilling: Roasting meat, browning

Heating function	Application
	True Fan Cooking: Even baking, tenderness, drying
	Frozen Foods: French fries, potato wedges, spring rolls

Heating function	Application
	Conventional Cooking: Traditional baking
	Pizza Function: Baking pizza
	Bottom Heat: Baking cakes
	Bread Baking: Bread, bread rolls
	Dough Proving: Proving yeast dough

SPECIALS

Heating function	Application
	Preserving: Preserving vegetables
	Dehydrating: Drying sliced fruit, mushrooms
	Plate Warming: Preheating plates
	Defrost: Defrosting
	Au Gratin: Making gratins, browning
	Slow Cooking: Preparing tender roast

Heating function	Application
	Keep Warm: Keeping food warm
	Moist Fan Baking: Baking

6.4 Notes on: Moist Fan Baking

This function was used to comply with the energy efficiency class and ecodesign requirements (according to EU 65/2014 and EU 66/2014). Tests according to:

For EU: IEC/EN 60350-1

For UK: BS EN 60350-1

The oven door should be closed during cooking so that the function is not interrupted and the oven operates with the highest energy efficiency possible.

When you use this function the lamp automatically turns off after 30 sec.

For general energy saving recommendations refer to "Energy Efficiency" chapter, Energy Saving.

This function is designed to save energy during cooking. When you use this function, the temperature in the cavity may differ from the set temperature. The heating power may be reduced.

7. CLOCK FUNCTIONS

7.1 Clock functions description

Clock function	Application
Cooking time	To set the length of cooking. Maximum is 23 h 59 min.
End action	To set what happens when the timer ends counting.
Delayed start	To postpone the start and / or end of cooking.
Time extension	To extend cooking time.
Reminder	To set a countdown. Maximum is 23 h 59 min. This function has no effect on the operation of the appliance.
Uptimer	Monitors how long the function operates. Uptimer - you can turn it on and off.

8. USING THE ACCESSORIES

WARNING!

Refer to Safety chapters.

8.1 Food Sensor

Food Sensor - measures the temperature inside the food. You can use it with every heating function.

There are two temperatures to be set:



The oven temperature: minimum 120 °C.



The core temperature.

8.2 How to use: Food Sensor

Step 1 Turn on the oven.

Step 2 Set a heating function and, if necessary, the oven temperature.

Step 3 Insert: Food Sensor.

Meat, poultry and fish

Insert the tip of Food Sensor into the centre of meat, fish, in the thickest part if possible. Make sure that at least 3/4 of Food Sensor is inside of the dish.

Casserole

Insert the tip of Food Sensor exactly in the centre of the casserole. Use the rim of the baking dish to support the silicone handle of Food Sensor. The tip of Food Sensor should not touch the bottom of a baking dish.

Step 4 Plug Food Sensor into the socket at the front of the oven.
The display shows the current temperature of: Food Sensor.

Step 5  - press to set the core temperature of the sensor.

Step 6

- ● ● - press to set the preferred option:
- Sound alarm - when food reaches the core temperature, the signal sounds.
- Sound alarm and stop cooking - when food reaches the core temperature, the signal sounds and the oven stops.

Step 7 Select the option and repeatedly press: **OK** to go to main screen.

Step 8 Press: **START** .
When food reaches the set temperature, the signal sounds. You can choose to stop or to continue cooking to make sure the food is well done.

Step 9 Remove Food Sensor plug from the socket and remove the dish from the oven.



WARNING!

There is a risk of burns as Food Sensor becomes hot. Be careful when you unplug it and remove it from the food.

9. CARE AND CLEANING

WARNING!

Refer to Safety chapters.

9.1 Notes on cleaning



Cleaning Agents

Clean the front of the appliance only with a microfibre cloth with warm water and a mild detergent.

Use a cleaning solution to clean metal surfaces.

Clean stains with a mild detergent.



Everyday Use

Clean the cavity after each use. Fat accumulation or other residue may cause fire.

Do not store the food in the appliance for longer than 20 minutes. Dry the cavity only with a microfibre cloth after each use.



Accessories

Clean all accessories after each use and let them dry. Use only a microfibre cloth with warm water and a mild detergent. Do not clean the accessories in a dishwasher.

Do not clean the non-stick accessories using abrasive cleaner or sharp-edged objects.

9.2 How to use: Pyrolytic Cleaning

Clean the oven with Pyrolytic Cleaning.

WARNING!

There is a risk of burns.

CAUTION!

If there are other appliances installed in the same cabinet, do not use them at the same time as this function. It can cause damage to the oven.

Before the Pyrolytic Cleaning:

Turn off the oven and wait until it is cold.

Remove all accessories and removable shelf supports.

Clean the oven floor and the inner door glass with warm water, a soft cloth and a mild detergent.

Step 1	Step 2	Step 3
Turn on the oven.	Press:  / Cleaning.	Select the cleaning mode.
Option	Cleaning mode	Duration
Pyrolytic cleaning, quick	Light cleaning	1 h
Pyrolytic cleaning, normal	Normal cleaning	1 h 30 min

Pyrolytic cleaning, intense	Thorough cleaning	3 h
-----------------------------	-------------------	-----

i When the cleaning starts, the oven door is locked and the lamp is off. The cooling fan works at a higher speed.

STOP - press to stop the cleaning before it is completed.
Do not use the oven until the door lock symbol disappears from the display.

When the cleaning ends:

Turn off the oven and wait until it is cold.	Clean the cavity with a soft cloth.	Remove the residue from the bottom of the cavity.
--	-------------------------------------	---

10. TROUBLESHOOTING

⚠ WARNING!

Refer to Safety chapters.

10.1 What to do if...



The appliance does not turn on or does not heat up



Possible cause



Remedy

The appliance is not connected to an electrical supply or it is connected incorrectly.

Check if the appliance is correctly connected to the electrical supply.

The clock is not set.

Set the clock, for details refer to Clock functions chapter, How to set: Clock functions.

The door is not closed correctly.

Fully close the door.

The fuse is blown.

Make sure the fuse is the cause of the problem. If the problem recurs, contact a qualified electrician.

The appliance Child Lock is on.

Refer to "Menu" chapter, Submenu for: Options.



Components



Description



Remedy

The lamp is burnt out.

Replace the lamp, for details refer to "Care and Cleaning" chapter, How to replace: Lamp.

Power cut always stops cleaning. Repeat cleaning if it's interrupted by power failure.



Problems with Wi-Fi signal



Possible cause



Remedy

Trouble with wireless network signal.

Check if your mobile device is connected to the wireless network.
Check your wireless network and router.
Restart the router.

New router installed or router configuration changed.

To configure appliance and mobile device again, refer to "Before first use" chapter, Wireless connection.

The wireless network signal is weak.

Move router as close to the appliance as possible.

The wireless signal is disrupted by another microwave oven placed near the appliance.

Turn off the microwave oven.
Avoid using another microwave oven and the Remote Control of the appliance at the same time. Microwaves disrupt Wi-Fi signal.

10.2 How to manage: Error codes

When the software error occurs, the display shows error message.

In this section, you will find the list of the problems that you can handle on your own.



Code and description



Remedy

C2 - the Food sensor is in the appliance cavity during Pyrolytic Cleaning.

Take out the Food sensor.

C3 - the door is not fully closed during Pyrolytic Cleaning.

Close the door.

F111 - Food sensor is not correctly inserted into the socket.

Fully plug Food sensor into the socket.

F240, F439 - the touch fields on the display do not work properly.

Clean the surface of the display. Make sure there is no dirt on the touch fields.

F601 - there is a problem with Wi-Fi signal.

Check your network connection. Refer to "Before first use" chapter, Wireless connection.

F604 - the first connection to Wi-Fi failed.

Turn the appliance off and on and try again. Refer to "Before first use" chapter, Wireless connection.

F908 - the appliance system cannot connect with the control panel.

Turn the appliance off and on.

When one of these error messages continues to appear on the display, it means a faulty subsystem may have been disabled. In such a case contact your dealer or an Authorized Service Centre. If one of these errors occurs, the rest of the appliance functions will continue to work as usually.



Code and description

F602, F603 - Wi-Fi is not available.



Remedy

Turn the appliance off and on.

10.3 Service data

If you cannot find a solution to the problem yourself, contact your dealer or an Authorised Service Centre.

The necessary data for the service centre is on the rating plate. The rating plate is on the front frame of the appliance cavity. Do not remove the rating plate from the appliance cavity.

We recommend that you write the data here:

Model (MOD.)

Product number (PNC)

Serial number (S.N.)

11. ENERGY EFFICIENCY

11.1 Product Information and Product Information Sheet

Supplier's name	AEG	
Model identification	BPE748380T 944188809 BPK748380B 944188806 BPK748380M 944188803 BPK748380T 944188807	
Energy Efficiency Index	61.2	
Energy efficiency class	A++	
Energy consumption with a standard load, conventional mode	1.09 kWh/cycle	
Energy consumption with a standard load, fan-forced mode	0.52 kWh/cycle	
Number of cavities	1	
Heat source	Electricity	
Volume	71 l	
Type of oven	Built-In Oven	
Mass	BPE748380T	35.0 kg
	BPK748380B	35.5 kg
	BPK748380M	36.0 kg
	BPK748380T	36.0 kg

For EU: IEC/EN 60350-1 - Household electric cooking appliances - Part 1: Ranges, ovens, steam ovens and grills - Methods for measuring performance.

11.2 Energy saving



The appliance has features which help you save energy during everyday cooking.

Make sure that the appliance door is closed when the appliance operates. Do not open the appliance door too often during cooking. Keep the door gasket clean and make sure it is well fixed in its position.

Use metal cookware to improve energy saving.

When possible, do not preheat the appliance before cooking.

Keep breaks between baking as short as possible when you prepare a few dishes at one time.

Cooking with fan

When possible, use the cooking functions with fan to save energy.

Residual heat

If a programme with Duration is activated and the cooking time is longer than 30 min, the heating elements automatically turn off earlier in some appliance functions.

The fan and lamp continue to operate. When you turn off the appliance, the display shows the residual heat. You can use that heat to keep the food warm.

When the cooking duration is longer than 30 min, reduce the appliance temperature to minimum 3 - 10 min before the end of cooking. The residual heat inside the appliance will continue to cook.

Use the residual heat to warm up other dishes.

Keep food warm

Choose the lowest possible temperature setting to use residual heat and keep a meal warm. The residual heat indicator or temperature appears on the display.

Cooking with the lamp off

Turn off the lamp during cooking. Turn it on only when you need it.

Moist Fan Baking

Function designed to save energy during cooking.

When you use this function the lamp automatically turns off after 30 sec. You may turn on the lamp again but this action will reduce the expected energy savings.

12. MENU STRUCTURE

12.1 Menu

Menu item	Application	
Assisted Cooking	Lists automatic programmes.	
Cleaning	Lists cleaning programmes.	
Favourites	Lists the favourite settings.	
Options	To set the appliance configuration.	
Settings	Connections	To set the network configuration.
	Setup	To set the appliance configuration.
	Service	Shows the software version and configuration.

12.2 Submenu for: Cleaning

Submenu	Application
Pyrolytic cleaning, quick	Duration: 1 h.
Pyrolytic cleaning, normal	Duration: 1 h 30 min.
Pyrolytic cleaning, intense	Duration: 3 h.

12.3 Submenu for: Options

Submenu	Application
Light	Turns the lamp on and off.
Child Lock	Prevents accidental activation of the appliance. When the option is on, the text Child Lock appears in the display when you turn on the appliance. To enable the appliance use, choose the code letters in the alphabetical order. When the option is on, and the appliance is turned off the appliance door is locked. Access to the timer, the remote operation and the lamp is available with the option on.
Fast Heat Up	Shortens the heat up time. It is available only for some of the appliance functions.
Cleaning Reminder	Turns the reminder on and off.
Time indication	Turns the clock on and off.
Digital clock style	Changes the format of the displayed time indication.

12.4 Submenu for: Connections

Submenu	Description
Wi-Fi	To enable and disable: Wi-Fi.
Remote operation	To enable and disable remote control. Option visible only after you turn on: Wi-Fi.
Auto remote operation	To start remote operation automatically after pressing START. Option visible only after you turn on: Wi-Fi.
Network	To check network status and the signal power of: Wi-Fi.
Forget network	To disable current network from auto connection with the appliance.

12.5 Submenu for: Setup

Submenu	Description
Language	Sets the appliance language.
Display brightness	Sets the display brightness.
Key tones	Turns the tone of the touch fields on and off. It is not possible to mute the tone for: ①.
Buzzer volume	Sets the volume of key tones and signals.

Submenu	Description
Time of day	Sets the current time and date.

12.6 Submenu for: Service

Submenu	Description
Demo mode	Activation / deactivation code: 2468
Software version	Information about software version.
Reset all settings	Restores factory settings.

13. IT'S EASY!



Before first use you have to set:

Language	Display brightness	Key tones	Buzzer volume	Time of day
----------	--------------------	-----------	---------------	-------------



Familiarize yourself with the basic icons on the control panel and the display:

 ON / OFF	 Menu	 Favourites	 Timer	 Food sensor	START / STOP
--	--	--	---	---	--------------

Start using the appliance

Quick start	Turn on the appliance and start cooking with the default temperature and time of the function.	Step 1 Press and hold:  .	Step 2  ... - select the preferred function.	Step 3 Press: START .
Quick Off	Turn off the appliance, any screen or message at any time.	 - press and hold until the appliance turns off.		

Start cooking

Step 1	Step 2	Step 3	Step 4	Step 5
 - press to turn on the appliance.	 ... - select the heating function.	 - set the temperature.	OK - press to confirm.	START - press to start cooking.

14. ENVIRONMENTAL CONCERNS

Recycle materials with the symbol . Put the packaging in relevant containers to recycle it. Help protect the environment and human

health by recycling waste of electrical and electronic appliances. Do not dispose of appliances marked with the symbol  with

the household waste. Return the product to your local recycling facility or contact your municipal office.





aeg.com

867380205-B-082023



**UK
CA** **CE**