

USER MANUAL



FOR PERFECT RESULTS

Thank you for choosing this AEG product. We have created it to give you impeccable performance for many years, with innovative technologies that help make life simpler – features you might not find on ordinary appliances. Please spend a few minutes reading to get the very best from it.

Visit our website to:



Get usage advice, brochures, trouble shooter, service and repair information:
www.aeg.com/support



Register your product for better service:
www.registeraeg.com



Buy Accessories, Consumables and Original spare parts for your appliance:
www.aeg.com/shop

CUSTOMER CARE AND SERVICE

Always use original spare parts.

When contacting our Authorised Service Centre, ensure that you have the following data available: Model, PNC, Serial Number.

The information can be found on the rating plate.

 Warning / Caution-Safety information

 General information and tips

 Environmental information

CONTENTS

1. SAFETY INFORMATION.....	3	5. BEFORE FIRST USE.....	12
1.1 Children and vulnerable people safety.....	3	5.1 Initial Cleaning	12
1.2 General Safety.....	4	5.2 First connection.....	13
2. SAFETY INSTRUCTIONS.....	5	5.3 Initial preheating.....	13
2.1 Installation.....	5	5.4 How to set: Water hardness.....	13
2.2 Electrical connection.....	6	6. DAILY USE.....	14
2.3 Use.....	7	6.1 How to set: Heating functions.....	14
2.4 Care and cleaning.....	7	6.2 Water drawer.....	15
2.5 Steam Cooking.....	8	6.3 How to use: Water drawer.....	15
2.6 Internal lighting.....	8	6.4 How to set: Steamify - Steam heating function.....	16
2.7 Service.....	8	6.5 How to set: SousVide Cooking.....	18
2.8 Disposal.....	8	6.6 How to set: Assisted Cooking.....	18
3. PRODUCT DESCRIPTION.....	9	6.7 Heating functions.....	19
3.1 General overview.....	9	6.8 Notes on: Moist Fan Baking.....	22
3.2 Accessories.....	9	7. CLOCK FUNCTIONS.....	22
4. HOW TO TURN OVEN ON AND OFF.....	10	7.1 Clock functions description.....	22
4.1 Control panel.....	10	7.2 How to set: Clock functions.....	23
4.2 Display.....	11		

8. HOW TO USE: ACCESSORIES.....	24	11.9 Drying reminder.....	38
8.1 Inserting accessories.....	24	11.10 How to use: Drying.....	38
8.2 Using Trivet and Grill- / Roasting pan.....	25	11.11 How to remove and install: Door.....	38
8.3 Food Sensor.....	26	11.12 How to replace: Lamp.....	39
9. ADDITIONAL FUNCTIONS.....	28	12. TROUBLESHOOTING.....	40
9.1 How to save: Favourites.....	28	12.1 What to do if.....	40
9.2 Function lock.....	28	12.2 How to manage: Error codes.....	42
9.3 Automatic switch-off.....	29	12.3 Service data.....	43
9.4 Cooling fan.....	29	13. ENERGY EFFICIENCY.....	43
10. HINTS AND TIPS.....	29	13.1 Product Information Sheet according to UK Ecodesign and Energy Labelling Regulations.....	43
10.1 Cooking recommendations.....	29	13.2 Energy saving.....	44
10.2 Moist Fan Baking.....	29	14. MENU STRUCTURE.....	45
10.3 Moist Fan Baking - recommended accessories.....	30	14.1 Menu.....	45
10.4 Cooking tables for test institutes..	31	14.2 Submenu for: Cleaning.....	45
11. CARE AND CLEANING.....	33	14.3 Submenu for: Options.....	46
11.1 Notes on cleaning.....	33	14.4 Submenu for: Setup.....	46
11.2 How to remove: Shelf supports ..	34	14.5 Submenu for: Service.....	47
11.3 How to use: Steam Cleaning.....	34	15. IT'S EASY!.....	47
11.4 Cleaning Reminder.....	35	16. TAKE A SHORTCUT!.....	49
11.5 How to clean: Water drawer.....	35	17. ENVIRONMENTAL CONCERNS.....	50
11.6 How to use: Descaling.....	36		
11.7 Descaling reminder.....	37		
11.8 How to use: Rinsing.....	37		

Subject to change without notice.

1. ⚠ SAFETY INFORMATION

Before the installation and use of the appliance, carefully read the supplied instructions. The manufacturer is not responsible for any injuries or damage that are the result of incorrect installation or usage. Always keep the instructions in a safe and accessible location for future reference.

1.1 Children and vulnerable people safety

- This appliance can be used by children aged from 8 years and above and persons with reduced physical, sensory or mental capabilities or lack of experience and knowledge if they have been given supervision or instruction concerning

SAFETY INFORMATION

the use of the appliance in a safe way and understand the hazards involved. Children of less than 8 years of age and persons with very extensive and complex disabilities shall be kept away from the appliance unless continuously supervised.

- Children should be supervised to ensure that they do not play with the appliance.
- Keep all packaging away from children and dispose of it appropriately.
- **WARNING:** The appliance and its accessible parts become hot during use. Keep children and pets away from the appliance when in use and when cooling down.
- If the appliance has a child safety device, it should be activated.
- Children shall not carry out cleaning and user maintenance of the appliance without supervision.

1.2 General Safety

- This appliance is for cooking purposes only.
- This appliance is designed for single household domestic use in an indoor environment.
- This appliance may be used in, offices, hotel guest rooms, bed & breakfast guest rooms, farm guest houses and other similar accommodation where such use does not exceed (average) domestic usage levels.
- Only a qualified person must install this appliance and replace the cable.
- Do not use the appliance before installing it in the built-in structure.
- Disconnect the appliance from the power supply before carrying out any maintenance.
- If the mains power supply cable is damaged, it must be replaced by the manufacturer, its Authorised Service Centre or similarly qualified persons to avoid an electrical hazard.

- The means for disconnection must be incorporated in the fixed wiring in accordance with the wiring rules.
- **WARNING:** Ensure that the appliance is switched off before replacing the lamp to avoid the possibility of electric shock.
- **WARNING:** The appliance and its accessible parts become hot during use. Care should be taken to avoid touching heating elements.
- Always use oven gloves to remove or insert accessories or ovenware.
- Use only the food sensor (core temperature sensor) recommended for this appliance.
- To remove the shelf supports first pull the front of the shelf support and then the rear end away from the side walls. Install the shelf supports in the opposite sequence.
- Do not use a steam cleaner to clean the appliance.
- Do not use harsh abrasive cleaners or sharp metal scrapers to clean the glass door since they can scratch the surface, which may result in shattering of the glass.

2. SAFETY INSTRUCTIONS

2.1 Installation

**WARNING!**

Only a qualified person must install this appliance.

- Remove all the packaging.
- Do not install or use a damaged appliance.
- Follow the installation instructions supplied with the appliance.
- Always take care when moving the appliance as it is heavy. Always use safety gloves and enclosed footwear.
- Do not pull the appliance by the handle.
- Install the appliance in a safe and suitable place that meets installation requirements.
- Keep the minimum distance from other appliances and units.
- Before mounting the appliance, check if the oven door opens without restraint.
- The appliance is equipped with an electric cooling system. It must be operated with the electric power supply.
- The built-in unit must meet the stability requirements of DIN 68930.

Cabinet minimum height (Cabinet under the work-top minimum height)	578 (600) mm
--	--------------

SAFETY INSTRUCTIONS

Cabinet width	560 mm
Cabinet depth	550 (550) mm
Height of the front of the appliance	594 mm
Height of the back of the appliance	576 mm
Width of the front of the appliance	595 mm
Width of the back of the appliance	559 mm
Depth of the appliance	567 mm
Built in depth of the appliance	546 mm
Depth with open door	1027 mm
Ventilation opening minimum size. Opening placed on the bottom rear side	560x20 mm
Mounting screws	4x25 mm

2.2 Electrical connection



WARNING!

Risk of fire and electric shock.

- All electrical connections should be made by a qualified electrician.
- The appliance must be earthed.
- Make sure that the parameters on the rating plate are compatible with the electrical ratings of the mains power supply.
- Always use a correctly installed shockproof socket.
- Do not use multi-plug adapters and extension cables.
- Make sure not to cause damage to the mains plug and to the mains cable. Should the mains cable need to be replaced, this must be carried out by our Authorised Service Centre.
- Do not let mains cables touch or come near the appliance door or the niche below the appliance, especially when it operates or the door is hot.
- The shock protection of live and insulated parts must be fastened in such a way that it cannot be removed without tools.
- Connect the mains plug to the mains socket only at the end of the installation. Make sure that there is access to the mains plug after the installation.
- If the mains socket is loose, do not connect the mains plug.
- Do not pull the mains cable to disconnect the appliance. Always pull the mains plug.
- Use only correct isolation devices: line protecting cut-outs, fuses (screw type fuses removed from the holder), earth leakage trips and contactors.

- The electrical installation must have an isolation device which lets you disconnect the appliance from the mains at all poles. The isolation device must have a contact opening width of minimum 3 mm.
- This appliance is supplied without a main plug and a main cable.

2.3 Use



WARNING!

Risk of injury, burns and electric shock or explosion.

- Do not change the specification of this appliance.
- Make sure that the ventilation openings are not blocked.
- Do not let the appliance stay unattended during operation.
- Deactivate the appliance after each use.
- Be careful when you open the appliance door while the appliance is in operation. Hot air can release.
- Do not operate the appliance with wet hands or when it has contact with water.
- Do not apply pressure on the open door.
- Do not use the appliance as a work surface or as a storage surface.
- Open the appliance door carefully. The use of ingredients with alcohol can cause a mixture of alcohol and air.
- Do not let sparks or open flames to come in contact with the appliance when you open the door.
- Do not put flammable products or items that are wet with flammable products in, near or on the appliance.



WARNING!

Risk of damage to the appliance.

- To prevent damage or discoloration to the enamel:
 - do not put ovenware or other objects in the appliance directly on the bottom.
 - do not put aluminium foil directly on the bottom of cavity of the appliance.
 - do not put water directly into the hot appliance.
 - do not keep moist dishes and food in the appliance after you finish the cooking.
 - be careful when you remove or install the accessories.
- Discoloration of the enamel or stainless steel has no effect on the performance of the appliance.
- Use a deep pan for moist cakes. Fruit juices cause stains that can be permanent.
- Always cook with the appliance door closed.
- If the appliance is installed behind a furniture panel (e.g. a door) make sure the door is never closed when the appliance operates. Heat and moisture can build up behind a closed furniture panel and cause subsequent damage to the appliance, the housing unit or the floor. Do not close the furniture panel until the appliance has cooled down completely after use.

2.4 Care and cleaning



WARNING!

Risk of injury, fire, or damage to the appliance.

- Before maintenance, deactivate the appliance and disconnect the mains plug from the mains socket.
- Make sure the appliance is cold. There is the risk that the glass panels can break.

SAFETY INSTRUCTIONS

- Replace immediately the door glass panels when they are damaged. Contact the Authorised Service Centre.
- Be careful when you remove the door from the appliance. The door is heavy!
- Clean regularly the appliance to prevent the deterioration of the surface material.
- Clean the appliance with a moist soft cloth. Use only neutral detergents. Do not use abrasive products, abrasive cleaning pads, solvents or metal objects.
- If you use an oven spray, follow the safety instructions on its packaging.

2.5 Steam Cooking



WARNING!

Risk of burns and damage to the appliance.

- Released Steam can cause burns:
 - Be careful when you open the appliance door when the function is activated. Steam can release.
 - Open the appliance door with care after the steam cooking operation.

2.6 Internal lighting



WARNING!

Risk of electric shock.

- Concerning the lamp(s) inside this product and spare part lamps sold separately: These lamps are intended to withstand extreme physical conditions in household appliances, such as temperature, vibration, humidity, or are intended to signal information about the operational status of the appliance. They are not intended to be used in other applications and are not suitable for household room illumination.
- This product contains a light source of energy efficiency class G.
- Use only lamps with the same specifications.

2.7 Service

- To repair the appliance contact the Authorised Service Centre.
- Use original spare parts only.

2.8 Disposal



WARNING!

Risk of injury or suffocation.

- Contact your municipal authority for information on how to dispose of the appliance.
- Disconnect the appliance from the mains supply.
- Cut off the mains electrical cable close to the appliance and dispose of it.
- Remove the door catch to prevent children or pets from becoming trapped in the appliance.

3. PRODUCT DESCRIPTION

3.1 General overview

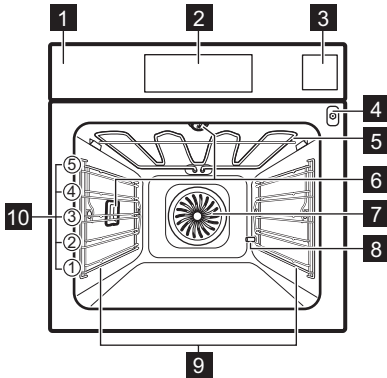

- 1** Control panel
- 2** Display
- 3** Water drawer
- 4** Socket for the food sensor
- 5** Heating element
- 6** Lamp
- 7** Fan
- 8** Descaling pipe outlet
- 9** Shelf support, removable
- 10** Shelf positions

3.2 Accessories

Wire shelf

For cookware, cake tins, roasts.

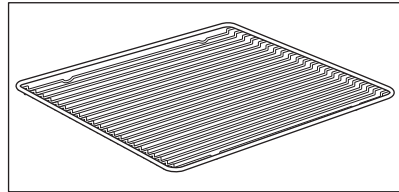

Grill- / Roasting pan

To bake and roast or as a pan to collect fat.

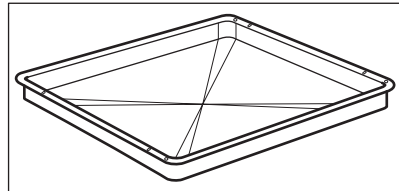

Trivet

For roasting and grilling.

Use the trivet only with the Grill- / Roasting pan.

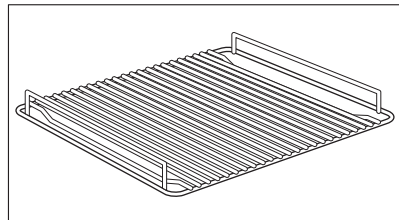

HOW TO TURN OVEN ON AND OFF

Patisserie tray

For rolls, pretzels and small pastries. Suitable for steam functions. The discolouration of the surface has no effect on the functions.

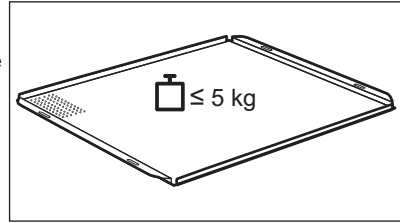

Food sensor

To measure the temperature inside food.

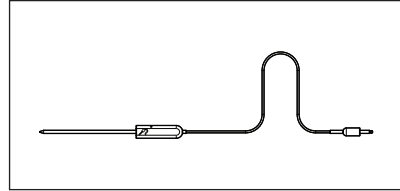

Telescopic runners

For inserting and removing trays and wireshelf more easily.

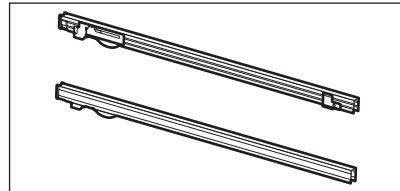

Steam set

One unperforated and one perforated food container.

The steam set drains the condensing water away from the food during steam cooking. Use it to prepare vegetables, fish, chicken breast. The set is not suitable for food that needs to soak in the water e.g. rice, polenta, pasta.

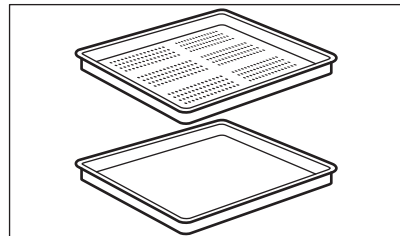

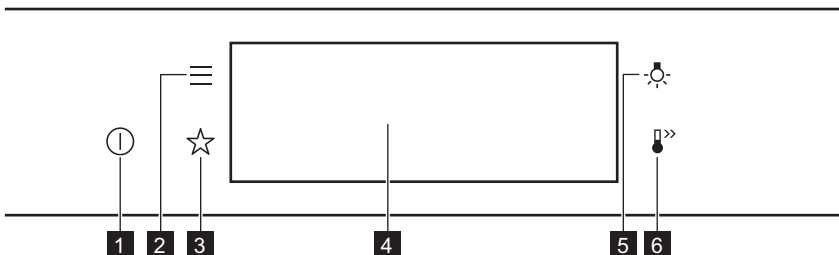

4. HOW TO TURN OVEN ON AND OFF

4.1 Control panel



HOW TO TURN OVEN ON AND OFF

1	ON / OFF	Press and hold to turn the oven on and off.
2	Menu	Lists the oven functions.
3	Favourites	Lists the favourite settings.
4	Display	Shows the current settings of the oven.
5	Lamp switch	To turn the lamp on and off.
6	Fast Heat Up	To turn on and off the function: Fast Heat Up.

 Press	 Move	 Press and hold
Touch the surface with fingertip.	Slide fingertip over the surface.	Touch the surface for 3 seconds.

4.2 Display

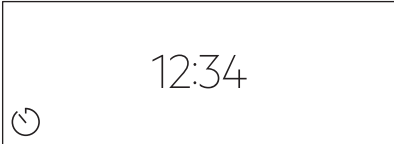
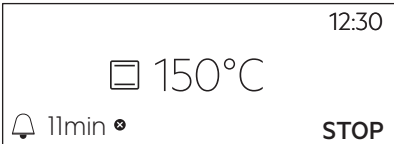
	After turning on, the display shows the main screen with the heating function and the default temperature.
	If you do not use the oven for 2 minutes, the display goes to standby.
	When you cook, the display shows the set functions and other available options.

BEFORE FIRST USE

	<p>Display with key functions set.</p> <ul style="list-style-type: none"> A. Time of day B. START/STOP C. Temperature D. Heating functions E. Timer F. Food sensor (selected models only)
--	---

<p>Display indicators</p>			
<p>Basic indicators - to navigate on the display.</p>			
<p>OK To confirm the selection / setting.</p>	<p>< To go one level back in the menu.</p>	<p>↶ To undo the last action.</p>	<p>⏻ To turn the options on and off.</p>
<p>Sound alarm function indicators - when the set time of cooking ends, the signal sounds.</p>			
<p>🔔 The function is on.</p>	<p>🔔 STOP The function is on. Cooking stops automatically.</p>	<p>🔔 Sound alarm is off.</p>	
<p>Timer indicators</p>			
<p>🕒 To set the function: Delayed start.</p>		<p>⊗ To cancel the setting.</p>	

5. BEFORE FIRST USE

<p>⚠ WARNING! Refer to Safety chapters.</p>
--

5.1 Initial Cleaning

<p>Step 1</p>	<p>Step 2</p>	<p>Step 3</p>





Remove all accessories and removable shelf supports from the oven.	Clean the oven and the accessories with a soft cloth, warm water and a mild detergent.	Place the accessories and the removable shelf supports in the oven.
--	--	---

5.2 First connection

The display shows welcome message after the first connection.

You have to set: Language, Display brightness, Key tones, Buzzer volume, Water hardness, Time of day.





5.3 Initial preheating

 Preheat the empty oven before the first use.	
Step 1	Remove all accessories and removable shelf supports from the oven.
Step 2	Set the maximum temperature for the function:  Let the oven operate for 1 h.
Step 3	Set the maximum temperature for the function:  Let the oven operate for 15 min.
 The oven can emit an odour and smoke during preheating. Make sure that the room is ventilated.	

5.4 How to set: Water hardness

When you connect the oven to the mains you have to set the water hardness level.





Use the test paper supplied with the steam set.

			
Step 1	Step 2	Step 3	Step 4
Put the test paper into water for about 1 sec. Do not put the test paper under running water.	Shake the test paper to remove the excess of water.	After 1 min, check water hardness with the table below.	Set the water hardness level: Menu / Settings / Setup / Water hardness.
 The colours of the test paper continue to change. Do not check water hardness later than 1 min after test.			

DAILY USE

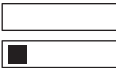
You can change the water hardness level in the menu: Settings / Setup / Water hardness.

The table shows water hardness range (dH) with the corresponding level of Calcium deposit and the water classification. Adjust the water hardness level according to the table.

Water hardness		Test paper	Calcium deposit (mmol/l)	Calcium deposit (mg/l)	Water classification
Level	dH				
1	0 - 7		0 - 1.3	0 - 50	soft
2	8 - 14		1.4 - 2.5	51 - 100	moderately hard
3	15 - 21		2.6 - 3.8	101 - 150	hard
4	≥22		≥ 3.9	≥151	very hard

When the tap water hardness level is 4, fill the water drawer with still bottled water.

6. DAILY USE



WARNING!

Refer to Safety chapters.

6.1 How to set: Heating functions

Step 1	Turn on the oven. The display shows the default heating function.
Step 2	Press the symbol of the heating function to enter the submenu.
Step 3	Select the heating function and press: OK . The display shows: temperature.
Step 4	Set: temperature. Press: OK .
Step 5	Press: START . Food Sensor - you can plug the sensor at any time before or during cooking.
STOP - press to turn off the heating function.	
Step 6	Turn off the oven.

Take a shortcut!



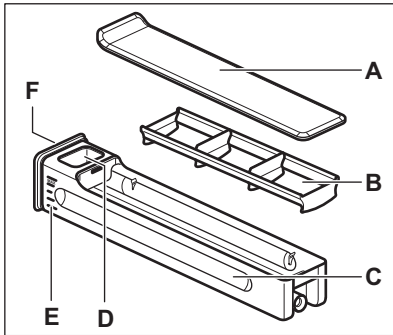

6.2 Water drawer



- A. Lid
- B. Wave-breaker
- C. Drawer
- D. Water-filling opening
- E. Scale
- F. Front cover

6.3 How to use: Water drawer

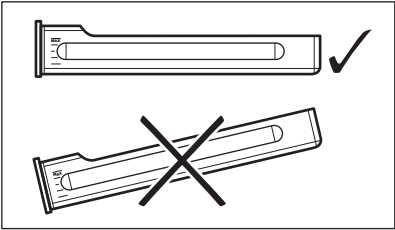
<p>Step 1</p>	<p>Push the front cover of the water drawer.</p>	
<p>Step 2</p>	<p>Fill the water drawer up to the maximum level. You can do it in two ways:</p>	
	<p>A: Leave the water drawer inside the oven and pour the water from a container.</p>	<p>B: Remove the water drawer from the oven and fill it from a water tap.</p>

Step 3	Carry the water drawer in the horizontal position to avoid water spilling.	
Step 4	When you fill the water drawer, insert it in the same position. Push the front cover until the water drawer is inside the oven.	
Step 5	Empty the water drawer after each use.	
 CAUTION! Keep the water drawer away from hot surfaces.		

6.4 How to set: Steamify - Steam heating function



Step 1	Turn on the oven. Select the symbol of the heating function and press it to enter the submenu.	
Step 2	Press  . Set the steam heating function.	
Step 3	Press: OK . The display shows the temperature settings.	
Step 4	Set the temperature. Type of the steam heating function depends on the set temperature.	
Steam for Steaming 50 - 100 °C		For steaming vegetables, grains, legumes, seafood, terrines and spoon desserts.
Steam for Stewing 105 - 130 °C		For cooking stewed and braised meat or fish, bread and poultry, as well as cheesecakes and casseroles.
Steam for Gentle Crisping 135 - 150 °C		For meat, casseroles, stuffed vegetables, fish and gratin. Owing to the combination of steam and heat the meat gets a juicy and tender texture along with crusty surface. If you set the timer, grill function turns on automatically in the last minutes of the cooking process to give dish a gentle gratin.

<p>Steam for Baking and Roasting 155 - 230 °C</p>	<p>For roasted and baked dishes meat, fish, poultry, filled puff pastry, tarts, muffins, gratin, vegetables and bakery dishes. If you set the timer and put the food on the first level, bottom heat function turns on automatically in the last minutes of the cooking process to give dish a crispy bottom.</p>
<p>Step 5</p>	<p>Press: OK.</p>
<p>Step 6</p>	<p>Press the cover of the water drawer to open and remove it.</p>
<p>Step 7</p>	<p>Fill the water drawer with cold water to the maximum level (around 950 ml). The water supply is sufficient for approximately 50 min.</p> <div data-bbox="213 580 1028 695" style="border: 1px solid black; padding: 5px;"> <p> WARNING! Use only cold tap water. Do not use filtered (demineralised) or distilled water. Do not use other liquids. Do not pour flammable or alcoholic liquids into the water drawer.</p> </div> <p>Use the scale on the water drawer.</p>
<p>Step 8</p>	<p>Wipe the outside of the water drawer with a soft cloth, if needed. Push the water drawer to its initial position.</p>
<p>Step 9</p>	<p>Press: START . Steam appears after approximately 2 min. When the oven reaches the set temperature, the signal sounds.</p>
<p>Step 10</p>	<p>When the water drawer runs out of water, the signal sounds. Refill the water drawer. At the end of cooking, the cooling fan runs quicker to remove steam.</p>
<p>Step 11</p>	<p>Turn off the oven.</p>
<p>Step 12</p>	<p>Empty the water drawer after cooking ends.</p>
<p>Step 13</p>	<p>Residual water can condensate in the cavity. After cooking, carefully open the oven door. When the oven is cold, dry the cavity with a soft cloth.</p>

Take a shortcut!



6.5 How to set: SousVide Cooking

Step 1	Turn on the oven. Select the symbol of the heating function and press it to enter the submenu.
Step 2	Press:  .
Step 3	Press: OK. The display shows the temperature settings.
Step 4	Set the temperature and press: OK.
Step 5	Press  . The display shows timer settings.
Step 6	Set the timer and press: OK.
Step 7	Press: START .
Step 8	Residual water can accumulate on the vacuum bags and in the cavity. After cooking, open the oven door carefully. Use a plate and a towel to take out the vacuum bags. When the oven is cold, remove the water from the bottom of the cavity with a sponge. Dry the cavity with a soft cloth.

Take a shortcut!



6.6 How to set: Assisted Cooking

Every dish in this submenu has a recommended function and temperature. You can adjust the time and the temperature.

For some of the dishes you can also cook with:

- Weight Automatic
- Food Sensor

The degree to which a dish is cooked:

- Rare or Less
- Medium
- Well done or More

Step 1	Turn on the oven.
Step 2	Press:  .





Step 3	Press:  . Enter: Assisted Cooking.
Step 4	Choose a dish or a food type.
Step 5	Press: START .

Take a shortcut!





6.7 Heating functions







STANDARD



Heating function	Application
 Grill	To grill thin pieces of food and to toast bread.
 Turbo Grilling	To roast large meat joints or poultry with bones on one shelf position. To make gratins and to brown.
 True Fan Cooking	To bake on up to three shelf positions at the same time and to dry food. Set the temperature 20 - 40 °C lower than for Conventional Cooking.
 Frozen Foods	To make convenience food (e.g., french fries, potato wedges or spring rolls) crispy.
 Conventional Cooking	To bake and roast food on one shelf position.

DAILY USE







Heating function	Application
 Pizza Function	To bake pizza. To make intensive browning and a crispy bottom.
 Bottom Heat	To bake cakes with crispy bottom and to preserve food.

SPECIALS



Heating function	Application
 Preserving	To preserve vegetables (e.g., pickles).
 Dehydrating	To dry sliced fruit, vegetables and mushrooms.
 Yoghurt Function	To prepare yogurt. The lamp in this function is off.
 Plate Warming	To preheat plates for serving.
 Defrost	To defrost food (vegetables and fruit). The defrosting time depends on the amount and size of the frozen food.
 Au Gratin	For dishes such as lasagna or potato gratin. To make gratins and to brown.
 Slow Cooking	To prepare tender, succulent roasts.

Heating function	Application
 <p>Keep Warm</p>	To keep food warm.
 <p>Moist Fan Baking</p>	This function is designed to save energy during cooking. When you use this function, the temperature in the cavity may differ from the set temperature. The residual heat is used. The heating power may be reduced. For more information refer to "Daily Use" chapter, Notes on: Moist Fan Baking.

STEAM

Heating function	Application
 <p>Steamify</p>	Use steam for steaming, stewing, gentle crisping, baking and roasting.
 <p>SousVide Cooking</p>	The function name refers to a method of cooking in vacuum sealed plastic pouches at low temperatures. Refer to the section SousVide Cooking below and the chapter "Hints and Tips" with the cooking tables to find more information.
 <p>Steam Regenerating</p>	Food reheating with steam prevents surface drying. Heat is distributed in a gentle and even way, which allows to recover taste and aroma of food as just prepared. This function can be used to reheat food directly on a plate. You can reheat more than one plate at the same time, using different shelf positions.
 <p>Bread Baking</p>	Use this function to prepare bread and bread rolls with a very good professional-like result in terms of crispiness, colour and crust gloss.
 <p>Dough Proving</p>	To speed up the rising of the yeast dough. It prevents dough surface from drying and keeps the dough elastic.
 <p>Full Steam</p>	For steaming vegetables, side dishes, fish

CLOCK FUNCTIONS

Heating function	Application
 Humidity High	The function is suitable for cooking delicate dishes like custards, flans, terrines and fish.
 Humidity Medium	The function is suitable for cooking stewed and braised meat as well as bread and sweet yeast dough. Due to the combination of steam and heat the meat gets a juicy and tender texture and yeast dough bakeries get a crispy and shiny surface.
 Humidity Low	The function is suitable for meat, poultry, oven dishes and casseroles. Thanks to the combination of steam and heat, meat gets a tender and juicy texture along with a crusty surface.

6.8 Notes on: Moist Fan Baking

This function was used to comply with the energy efficiency class and ecodesign requirements. Tests according to BS EN 60350-1.

The oven door should be closed during cooking so that the function is not interrupted and the oven operates with the highest energy efficiency possible.

When you use this function the lamp automatically turns off after 30 sec.

For the cooking instructions refer to "Hints and tips" chapter, Moist Fan Baking. For general energy saving recommendations refer to "Energy Efficiency" chapter, Energy Saving.

7. CLOCK FUNCTIONS

7.1 Clock functions description

Clock function	Application
Cooking time	To set the length of cooking. Maximum is 23 h 59 min.
End action	To set what happens when the timer ends counting.
Delayed start	To postpone the start and / or end of cooking.
Time extension	To extend cooking time.
Reminder	To set a countdown. Maximum is 23 h 59 min. This function has no effect on the operation of the oven.
Uptimer	Monitors how long the function operates. Uptimer - you can turn it on and off.

7.2 How to set: Clock functions

How to set the clock	
Step 1	Press: Time of day.
Step 2	Set the time. Press: OK.

How to set cooking time	
Step 1	Choose the heating function and set the temperature.
Step 2	Press:  .
Step 3	Set the time. Press: OK.

Take a shortcut!



How to choose end option	
Step 1	Choose the heating function and set the temperature.
Step 2	Press:  .
Step 3	Set the cooking time.
Step 4	Press: ● ● ● .
Step 5	Press: End action.
Step 6	Choose the preferred: End action.
Step 7	Press: OK. Repeat the action until the display shows the main screen.

HOW TO USE: ACCESSORIES

How to delay start of cooking	
Step 1	Set the heating function and the temperature.
Step 2	Press:  .
Step 3	Set the cooking time.
Step 4	Press: ● ● ● .
Step 5	Press: Delayed start.
Step 6	Choose the value.
Step 7	Press: OK. Repeat the action until the display shows the main screen.

How to extend cooking time	
When 10% of cooking time is left and the food seems not to be ready, you can extend cooking time. You can also change the heating function.	
Press +1min to extend the cooking time.	

How to change timer settings	
Step 1	Press:  .
Step 2	Set the timer value.
Step 3	Press: OK.
You can change the set time during cooking at any time.	

8. HOW TO USE: ACCESSORIES

8.1 Inserting accessories

A small indentation at the top increases safety. The indentations are also anti-tip devices. The high rim around the shelf prevents cookware from slipping of the shelf.

Wire shelf:

Push the shelf between the guide bars of the shelf support.

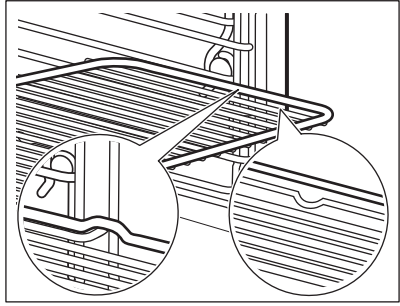
**Deep pan:**

Push the tray between the guide bars of the shelf support.

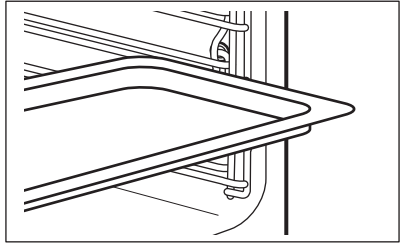
**Wire shelf, Deep pan:**

Push the tray between the guide bars of the shelf support and the wire shelf on the guide bars above.

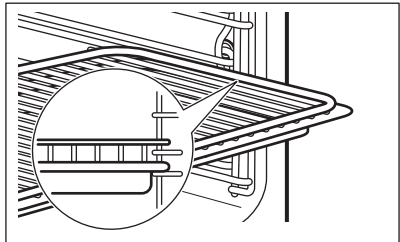

8.2 Using Trivet and Grill- / Roasting pan

**WARNING!**

Be careful when you remove the accessories from a hot oven. There is a risk of burns.

You can use the trivet to roast larger pieces of meat or poultry on one shelf position.

HOW TO USE: ACCESSORIES

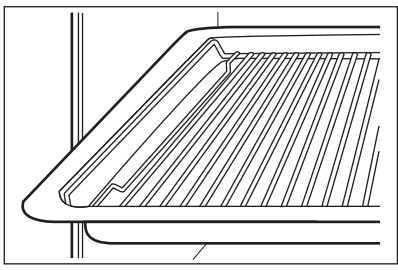
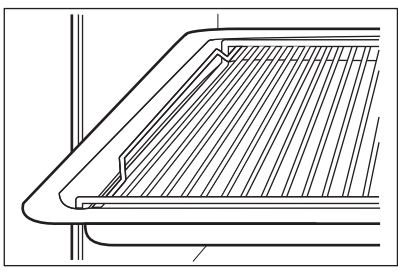
<p>Step 1</p>	<p>Put the trivet into the deep pan so that the supports of the wire shelf point up.</p>	
<p>Step 2 Put the deep pan into the oven on the necessary shelf position.</p>		
<p>You can use the trivet to grill flat dishes in large quantities and to toast.</p>		
<p>Step 1</p>	<p>Put the trivet into the deep pan so that the supports of the wire shelf point down.</p>	
<p>Step 2 Put the deep pan into the oven on the necessary shelf position.</p>		

8.3 Food Sensor



Food Sensor- measures the temperature inside the food. You can use it with every heating function.

<p>There are two temperatures to be set:</p>	
<p style="text-align: center;">°C</p> <p>The oven temperature: minimum 120 °C.</p>	<p style="text-align: center;"></p> <p>The core temperature.</p>

<p>For the best cooking results:</p>		
<p>Ingredients should be at room temperature.</p>	<p>Do not use it for liquid dishes.</p>	<p>During cooking it must remain in the dish.</p>

The oven calculates an approximate end of cooking time. It depends on the quantity of food, the set oven function and the temperature.

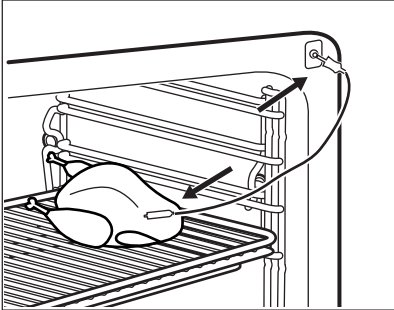
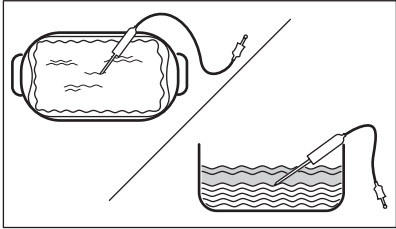
How to use: Food Sensor

Step 1	Turn on the oven.
Step 2	Set a heating function and, if necessary, the oven temperature.
Step 3	Insert: Food Sensor.
Meat, poultry and fish	Casserole
<p>Insert the tip of Food Sensor into the centre of meat, fish, in the thickest part if possible. Make sure that at least 3/4 of Food Sensor is inside of the dish.</p>	<p>Insert the tip of Food Sensor exactly in the centre of the casserole. Food Sensor should be stabilized in one place during baking. Use a solid ingredient to achieve that. Use the rim of the baking dish to support the silicone handle of Food Sensor. The tip of Food Sensor should not touch the bottom of a baking dish.</p>
	
Step 4	Plug Food Sensor into the socket at the front of the oven. The display shows the current temperature of: Food Sensor.
Step 5	 - press to set the core temperature of the sensor.
Step 6	<ul style="list-style-type: none"> ● ● ● - press to set the preferred option: <ul style="list-style-type: none"> • Sound alarm - when food reaches the core temperature, the signal sounds. • Sound alarm and stop cooking - when food reaches the core temperature, the signal sounds and the oven stops.
Step 7	Select the option and repeatedly press: OK to go to main screen.
Step 8	<p>Press: START .</p> <p>When food reaches the set temperature, the signal sounds. You can choose to stop or to continue cooking to make sure the food is well done.</p>

ADDITIONAL FUNCTIONS

Step 9	Remove Food Sensor plug from the socket and remove the dish from the oven.  WARNING! There is a risk of burns as Food Sensor becomes hot. Be careful when you unplug it and remove it from the food.
---------------	--



Take a shortcut!



9. ADDITIONAL FUNCTIONS



9.1 How to save: Favourites

You can save your favourite settings, such as the heating function, the cooking time, the temperature or the cleaning function. You can save 3 favourite settings.

Step 1	Turn on the oven.
Step 2	Select the preferred setting.
Step 3	Press:  . Select: Favourites.
Step 4	Select: Save current settings.
Step 5	Press + to add the setting to the list of: Favourites. Press OK .
 - press to reset the setting.  - press to cancel the setting.	



9.2 Function lock

This function prevents an accidental change of the heating function.

Step 1	Turn on the oven.
Step 2	Set a heating function.
Step 3	  - press at the same time to turn on the function.
To turn off the function repeat step 3.	

9.3 Automatic switch-off

For safety reasons the oven turns off after some time, if a heating function works and you do not change any settings.

 (°C)	 (h)
30 - 115	12.5
120 - 195	8.5
200 - 230	5.5

The Automatic switch-off does not work with the functions: Light, Food sensor, End time, Slow Cooking.

9.4 Cooling fan

When the oven operates, the cooling fan turns on automatically to keep the surfaces of the oven cool. If you turn off the oven, the cooling fan can continue to operate until the oven cools down.





10. HINTS AND TIPS

10.1 Cooking recommendations







<p>The temperature and cooking times in the tables are guidelines only. They depend on the recipes and the quality and quantity of the ingredients used.</p> <p>Your oven may bake or roast differently to the oven you had before. The hints below show recommended settings for temperature, cooking time and shelf position for specific types of the food.</p> <p>If you cannot find the settings for a special recipe, look for the similar one.</p> <p>For more cooking recommendations refer to cooking tables on our website. To find the Cooking Hints check the PNC number on the rating plate on the front frame of the oven cavity.</p>

10.2 Moist Fan Baking

For the best results follow suggestions listed in the table below.





		 (°C)		 (min)
Sweet rolls, 16 pieces	baking tray or dripping pan	180	2	25 - 35

HINTS AND TIPS

		 (°C)		 (min)
Swiss Roll	baking tray or dripping pan	180	2	15 - 25
Whole fish, 0.2 kg	baking tray or dripping pan	180	3	15 - 25
Cookies, 16 pieces	baking tray or dripping pan	180	2	20 - 30
Macaroons, 24 pieces	baking tray or dripping pan	160	2	25 - 35
Muffins, 12 pieces	baking tray or dripping pan	180	2	20 - 30
Savory pastry, 20 pieces	baking tray or dripping pan	180	2	20 - 30
Short crust biscuits, 20 pieces	baking tray or dripping pan	140	2	15 - 25
Tartlets, 8 pieces	baking tray or dripping pan	180	2	15 - 25

10.3 Moist Fan Baking - recommended accessories







Use the dark and non-reflective tins and containers. They have better heat absorption than the light colour and reflective dishes.







			
Pizza pan	Baking dish	Ramekins	Flan base tin
Dark, non-reflective 28 cm diameter	Dark, non-reflective 26 cm diameter	Ceramic 8 cm diameter, 5 cm height	Dark, non-reflective 28 cm diameter

10.4 Cooking tables for test institutes







Information for test institutes







Tests according to: EN 60350, IEC 60350.

 BAKING ON ONE LEVEL. Baking in tins				
		 (°C)	 (min)	
Fatless sponge cake	True Fan Cooking	140 - 150	35 - 50	2
Fatless sponge cake	Conventional Cooking	160	35 - 50	2
Apple pie, 2 tins Ø20 cm	True Fan Cooking	160	60 - 90	2
Apple pie, 2 tins Ø20 cm	Conventional Cooking	180	70 - 90	1

 BAKING ON ONE LEVEL. Biscuits				
 Use the third shelf position.				
		 (°C)	 (min)	
Short bread / Pastry strips	True Fan Cooking	140	25 - 40	
Short bread / Pastry strips, preheat the empty oven	Conventional Cooking	160	20 - 30	
Small cakes, 20 per tray, preheat the empty oven	True Fan Cooking	150	20 - 35	
Small cakes, 20 per tray, preheat the empty oven	Conventional Cooking	170	20 - 30	







HINTS AND TIPS

 MULTILEVEL BAKING. Biscuits				
		 (°C)	 (min)	
Short bread / Pastry strips	True Fan Cooking	140	25 - 45	1 / 4
Small cakes, 20 per tray, preheat the empty oven	True Fan Cooking	150	23 - 40	1 / 4
Fatless sponge cake	True Fan Cooking	160	35 - 50	1 / 4

 GRILL				
 Preheat the empty oven for 5 minutes.				
 Grill with the maximum temperature setting.				
		 (min)		
Toast	Grill	1 - 3	5	
Beef steak, turn halfway through	Grill	24 - 30	4	

Information for test institutes

Tests for the function: Full Steam.
Tests according to IEC 60350.

 Set the temperature to 100 °C.					
	 Container (Gastronorm)	 (kg)		 (min)	
Broccoli, pre-heat the empty oven	1 x 2/3 perforated	0.3	3	8 - 9	Put the baking tray on the first shelf position.
Broccoli, pre-heat the empty oven	1 x 2/3 perforated	max.	3	10 - 11	Put the baking tray on the first shelf position.
Peas, frozen	2 x 2/3 perforated	2 x 1.5	2 and 4	Until the temperature in the coldest spot reaches 85 °C.	Put the baking tray on the first shelf position.

11. CARE AND CLEANING



WARNING!

Refer to Safety chapters.

11.1 Notes on cleaning

 Cleaning Agents	Clean the front of the oven with a soft cloth with warm water and a mild detergent. Clean the bottom of the cavity with a few drops of vinegar to remove limestone residue.
	Use a cleaning solution to clean metal surfaces.
	Clean stains with a mild detergent.

CARE AND CLEANING

 <p>Everyday Use</p>	<p>Clean the cavity after each use. Fat accumulation or other residue may cause fire.</p>
	<p>Do not store the food in the oven for longer than 20 minutes. Dry the cavity with a soft cloth after each use.</p>

 <p>Accessories</p>	<p>Clean all accessories after each use and let them dry. Use a soft cloth with warm water and a mild detergent. Do not clean the accessories in a dishwasher.</p>
	<p>Do not clean the non-stick accessories using abrasive cleaner or sharp-edged objects.</p>

11.2 How to remove: Shelf supports

Remove the shelf supports to clean the oven.

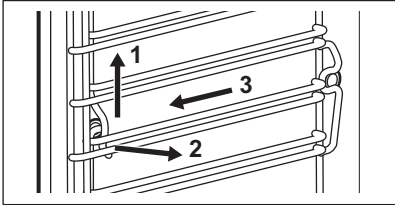
Step 1	Turn off the oven and wait until it is cold.	
Step 2	Carefully pull the shelf supports up and out of the front catch.	
Step 3	Pull the front end of the shelf support away from the side wall.	
Step 4	Pull the supports out of the rear catch.	
<p>Install the shelf supports in the opposite sequence.</p>		

11.3 How to use: Steam Cleaning

Before you start:		
Turn off the oven and wait until it is cold.	Remove all accessories and removable shelf supports.	Clean the bottom of the cavity and the inner door glass with a soft cloth with warm water and a mild detergent.

Step 1	Fill the water drawer to the maximum level.
Step 2	Select: Menu / Cleaning.

Function	Description	Duration
Steam Cleaning	Light cleaning	30 min
Steam Cleaning Plus	Normal cleaning Spray the cavity with a detergent.	75 min
Step 3	Press START . Follow the instruction on the display. The signal sounds when the cleaning ends.	
Step 4	Press any symbol to turn off the signal.	
<p>i When this function works, the lamp is off.</p>		

When the cleaning ends:		
Turn off the oven.	When the oven is cold, dry the cavity with a soft cloth. Remove the remaining water from the water drawer.	Leave the oven door open and wait until the cavity is dry.

11.4 Cleaning Reminder

When the reminder appears, cleaning is recommended.
Use the function: Steam Cleaning Plus.

11.5 How to clean: Water drawer

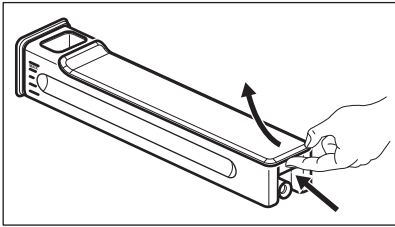
Step 1	Remove the water drawer from the oven.	
Step 2	Remove the lid of the water drawer. Lift the cover in correspondence with the protrusion in the rear.	
Step 3	Remove the wave-breaker. Pull it away from the drawer body until it pops out.	

CARE AND CLEANING

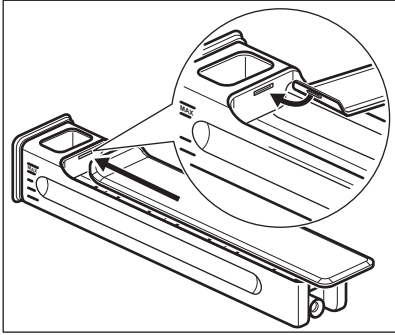
Step 4	Wash the water drawer parts with water and soap. Do not use abrasive sponges and do not clean the water drawer in a dishwasher.	
Step 5	Reassemble the water drawer.	
Step 6	Snap in the wave-breaker. Push it into the drawer body.	
Step 7	Assemble the lid. First insert the front snap and then push it against the drawer body.	
Step 8	Insert the water drawer.	
Step 9	Push the water drawer towards the oven until it latches.	

11.6 How to use: Descaling

Before you start:		
Turn off the oven and wait until it is cold.	Remove all accessories.	Make sure that the water drawer is empty.

Duration of the first part: around 100 min	
Step 1	Place the deep pan on the first shelf position.
Step 2	Pour 250 ml of the descaling agent in the water drawer.
Step 3	Fill the remaining part of the water drawer with water to the maximum level.
Step 4	Select: Menu / Cleaning.
Step 5	Turn on the function and follow the instruction on the display. The first part of descaling starts.
Step 6	After the first part is over, empty the deep pan and put it back on the first shelf position.
Duration of the second part: around 35 min	
Step 7	Fill the water drawer with water. Make sure there is no remaining descaling agent inside the water drawer. Insert the water drawer.

Step 8	When the function ends, remove the deep pan.
<p>i When this function works, the lamp is off.</p>	

When descaling ends:		
Turn off the oven.	When the oven is cold, dry the cavity with a soft cloth. Remove the remaining water from the water drawer.	Leave the oven door open and wait until the cavity is dry.
<p>i If some limestone residue remains in the oven after descaling, the display prompts to repeat the procedure.</p>		

11.7 Descaling reminder

There are two reminders which prompt you to descale the oven. You cannot disable the descaling reminder.

Type	Description
Soft reminder	Recommends you to descale the oven.
Hard reminder	Obligates you to descale the oven. If you do not descale the oven when the hard reminder is on, the steam functions are disabled.

11.8 How to use: Rinsing

Before you start:	
Turn off the oven and wait until it is cold.	Remove all accessories.

Step 1	Place the deep pan on the first shelf position.
Step 2	Fill the water drawer with water.
Step 3	Select: Menu / Cleaning / Rinsing. Duration: around 30 min
Step 4	Turn on the function and follow the instruction on the display.
Step 5	When the function ends, remove the deep pan.

CARE AND CLEANING

 When this function works, the lamp is off.

11.9 Drying reminder

After cooking with a steam heating function the display prompts to dry the oven. Press YES to dry the oven.

11.10 How to use: Drying

Use it after cooking with a steam heating function or steam cleaning to dry the cavity.

Step 1	Make sure the oven is cold.
Step 2	Remove all accessories.
Step 3	Select the menu: Cleaning / Drying.
Step 4	Follow the instructions on the screen.

11.11 How to remove and install: Door

You can remove the door and the internal glass panels to clean it. The number of glass panels is different for different models.



WARNING!

The door is heavy.



CAUTION!

Carefully handle the glass, especially around the edges of the front panel. The glass can break.

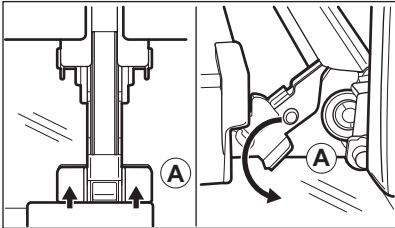
Step 1	Fully open the door.	
Step 2	Lift and press the clamping levers (A) on the two door hinges.	
Step 3	Close the oven door to the first opening position (approximately 70° angle). Hold the door at both sides and pull it away from the oven at an upwards angle. Put the door with the outer side down on a soft cloth on a stable surface.	

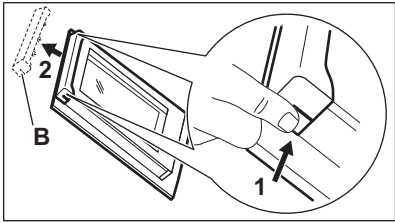
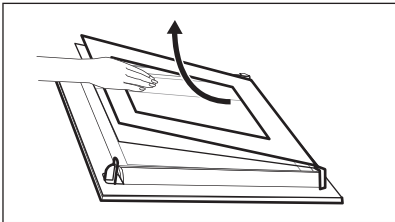
<p>Step 4</p>	<p>Hold the door trim (B) on the top edge of the door at the two sides and push inwards to release the clip seal.</p>	
<p>Step 5</p>	<p>Pull the door trim to the front to remove it.</p>	
<p>Step 6</p>	<p>Hold the door glass panels on their top edge one by one and pull them up out of the guide.</p>	
<p>Step 7</p>	<p>Clean the glass panel with water and soap. Dry the glass panel carefully. Do not clean the glass panels in the dishwasher.</p>	
<p>Step 8</p>	<p>After cleaning, do the above steps in the opposite sequence.</p>	
<p>Step 9</p>	<p>Install the smaller panel first, then the larger and the door. Make sure that the glasses are inserted in the correct position otherwise the surface of the door may overheat.</p>	

11.12 How to replace: Lamp



WARNING!

Risk of electric shock.
The lamp can be hot.

Before you replace the lamp:

Step 1	Step 2	Step 3
<p>Turn off the oven. Wait until the oven is cold.</p>	<p>Disconnect the oven from the mains.</p>	<p>Put a cloth on the bottom of the cavity.</p>

TROUBLESHOOTING

Top lamp

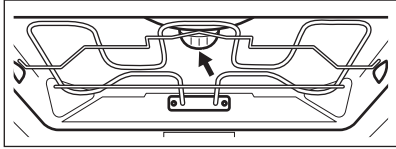
Step 1	Turn the glass cover to remove it.	
Step 2	Remove the metal ring and clean the glass cover.	
Step 3	Replace the lamp with a suitable 300 °C heat-resistant lamp.	
Step 4	Attach the metal ring to the glass cover and install it.	

Side lamp

Step 1	Remove the left shelf support to get access to the lamp.
Step 2	Use a Torx 20 screwdriver to remove the cover.
Step 3	Remove and clean the metal frame and the seal.
Step 4	Replace the lamp with a suitable 300 °C heat-resistant lamp.
Step 5	Install the metal frame and the seal. Tighten the screws.
Step 6	Install the left shelf support.



12. TROUBLESHOOTING



WARNING!



Refer to Safety chapters.

12.1 What to do if...

 The oven does not turn on or does not heat up	
 Possible cause	 Remedy
The oven is not connected to an electrical supply or it is connected incorrectly.	Check if the oven is correctly connected to the electrical supply.





The oven does not turn on or does not heat up

 Possible cause	 Remedy
The clock is not set.	Set the clock, for details refer to "Clock Functions" chapter, How to set: Clock functions.
The door is not closed correctly.	Fully close the door.
The fuse is blown.	Make sure the fuse is the cause of the problem. If the problem recurs, contact a qualified electrician.
The oven Child Lock is on.	Refer to "Menu" chapter, Submenu for: Options.





Components





 Description	 Remedy
The lamp is burnt out.	Replace the lamp, for details refer to "Care and Cleaning" chapter, How to replace: Lamp.



Water drawer does not work properly

 Description	 Possible cause	 Remedy
The oven does not retain the water drawer after you insert it.	You did not fully press the water drawer body.	Fully insert the water drawer into the oven.
Water comes out of the water drawer.	You did not assemble the lid of the water drawer or wave breaker correctly.	Reassemble the lid of the water drawer and wave breaker.

TROUBLESHOOTING



 Problems with cleaning procedure		
 Description	 Possible cause	 Remedy
The water drawer is difficult to clean.	The lid and the wave breaker were not removed.	Remove the lid and the wave breaker.
There is no water inside the grill -/ roasting pan after descaling.	The water drawer was not filled in to the maximum level.	Check if a descaling agent / water is present in the water drawer body.
There is dirty water on the bottom of the cavity after descaling.	The grill -/ roasting pan is on a wrong shelf position.	Remove the remaining water and the descaling agent from the bottom of the oven. Next time put the grill -/ roasting pan on the first shelf position.
There is too much water on the bottom of the cavity after cleaning.	You put too much detergent in the oven before you started cleaning.	Next time evenly spread the thin layer of a detergent on the cavity walls.
Cleaning performance is not satisfactory.	You started cleaning when the oven was too hot.	Wait until the oven is cold. Repeat cleaning.
	You did not remove all the accessories from the oven before cleaning.	Remove all the accessories from the oven. Repeat cleaning.



Power cut always stops cleaning. Repeat cleaning if it's interrupted by power failure.

12.2 How to manage: Error codes



When the software error occurs, the display shows error message.

In this section, you will find the list of the problems that you can handle on your own.

 Code and description	 Remedy
F111 - Food sensor is not correctly inserted into the socket.	Fully plug Food sensor into the socket.
F240, F439 - the touch fields on the display do not work properly.	Clean the surface of the display. Make sure there is no dirt on the touch fields.

 Code and description	 Remedy
F908 - the oven system cannot connect with the control panel.	Turn the oven off and on.

When one of these error messages continues to appear on the display, it means a faulty subsystem may have been disabled. In such a case contact your dealer or an Authorized Service Centre. If one of these errors occurs, the rest of the oven functions will continue to work as usually.

 Code and description	 Remedy
F131 - the temperature of the steamer sensor is too high.	Turn the oven off and wait until it cools down. Turn the oven on again.
F144 - the sensor in the Water drawer cannot measure the water level.	Empty the Water drawer and refill it.
F508 - the Water drawer does not work properly.	Turn the oven off and on.

12.3 Service data

If you cannot find a solution to the problem yourself, contact your dealer or an Authorised Service Centre.

The necessary data for the service centre is on the rating plate. The rating plate is on the front frame of the oven cavity. Do not remove the rating plate from the oven cavity.

We recommend that you write the data here:	
Model (MOD.)
Product number (PNC)
Serial number (S.N.)

13. ENERGY EFFICIENCY

13.1 Product Information Sheet according to UK Ecodesign and Energy Labelling Regulations

Supplier's name	AEG
-----------------	-----

ENERGY EFFICIENCY

Model identification	BSK798380M 944188691
Energy Efficiency Index	61.9
Energy efficiency class	A++
Energy consumption with a standard load, conventional mode	0.99 kWh/cycle
Energy consumption with a standard load, fan-forced mode	0.52 kWh/cycle
Number of cavities	1
Heat source	Electricity
Volume	70 l
Type of oven	Built-In Oven
Mass	40.5 kg

BS EN 60350-1 - Household electric cooking appliances - Part 1: Ranges, ovens, steam ovens and grills - Methods for measuring performance.

13.2 Energy saving



The oven has features which help you save energy during everyday cooking.

Make sure that the oven door is closed when the oven operates. Do not open the oven door too often during cooking. Keep the door gasket clean and make sure it is well fixed in its position.

Use metal cookware to improve energy saving.

When possible, do not preheat the oven before cooking.

Keep breaks between baking as short as possible when you prepare a few dishes at one time.

Cooking with fan

When possible, use the cooking functions with fan to save energy.

Residual heat

If a programme with the Duration or End Time selection is activated and the cooking time is longer than 30 min, the heating elements automatically turn off earlier in some oven functions.

The fan and lamp continue to operate. When you turn off the oven, the display shows the residual heat. You can use that heat to keep the food warm.

When the cooking duration is longer than 30 min, reduce the oven temperature to minimum 3 - 10 min before the end of cooking. The residual heat inside the oven will continue to cook.

Use the residual heat to warm up other dishes.

Keep food warm

Choose the lowest possible temperature setting to use residual heat and keep a meal warm.

The residual heat indicator or temperature appears on the display.

Cooking with the lamp off

Turn off the lamp during cooking. Turn it on only when you need it.

Moist Fan Baking

Function designed to save energy during cooking.

When you use this function the lamp automatically turns off after 30 sec. You may turn on the lamp again but this action will reduce the expected energy savings.

14. MENU STRUCTURE

14.1 Menu

Press  to open Menu.

Menu item		Application
Assisted Cooking		Lists automatic programmes.
Cleaning		Lists cleaning programmes.
Favourites		Lists the favourite settings.
Options		To set the oven configuration.
Settings	Setup	To set the oven configuration.
	Service	Shows the software version and configuration.

14.2 Submenu for: Cleaning

Submenu	Application
Drying	Procedure for drying the cavity from the condensation remaining after a use of the steam functions.
Steam Cleaning	Light cleaning.
Steam Cleaning Plus	Thorough cleaning.
Descaling	Cleaning of the steam generation circuit from residual limestone.
Rinsing	Cleaning of the steam generation circuit. Use rinsing after frequent steam cooking.

MENU STRUCTURE

14.3 Submenu for: Options

Submenu	Application
Light	Turns the lamp on and off.
Child Lock	Prevents accidental activation of the oven. When the option is on, the text "Child Lock" appears on the display when you turn on the oven. To enable the oven use, choose the code letters in the alphabetical order. Access to the timer, the remote operation and the lamp is available with the Child Lock on.
Fast Heat Up	Shortens heat up time. It is available only for some of the oven functions.
Cleaning Reminder	Turns the reminder on and off.
Time indication	Turns the clock on and off.
Digital clock style	Changes the format of the displayed time indication.

14.4 Submenu for: Setup

Submenu	Description
Language	Sets the oven language.
Display brightness	Sets the display brightness.
Key tones	Turns the tone of the touch fields on and off. It is not possible to mute the tone for: ①.
Buzzer volume	Sets the volume of key tones and signals.
Water hardness	Sets the water hardness.
Time of day	Sets the current time and date.

14.5 Submenu for: Service





Submenu	Description
Demo mode	Activation / deactivation code: 2468
Software version	Information about software version.
Reset all settings	Restores factory settings.

15. IT'S EASY!



Before the first use you have to set:

Language	Display brightness	Key tones	Buzzer volume	Water hardness	Time of day
----------	--------------------	-----------	---------------	----------------	-------------

Familiarize yourself with the basic icons on the control panel and the display:

 ON / OFF	 Menu	 Favourites	 Timer	 Food sensor	START / STOP
---	---	---	--	--	--------------



Start using the oven

Quick start	Turn on the oven and start cooking with the default temperature and time of the function.	Step 1	Step 2	Step 3
		Press and hold: 	 ... - select the preferred function.	Press: START .
Quick Off	Turn off the oven, any screen or message at any time.	 - press and hold until the oven turns off.		



Start cooking

Step 1	Step 2	Step 3	Step 4	Step 5
---------------	---------------	---------------	---------------	---------------



IT'S EASY!

Start cooking				
 - press to turn on the oven.	 ... - select the heating function.	 - set the temperature.	OK - press to confirm.	START - press to start cooking.

Steam cooking - Steamify			
Set the temperature. Type of the steam heating function depends on the set temperature.			
Steam for Steaming	Steam for Stewing	Steam for Gentle Crisping	Steam for Baking and Roasting
50 - 100 °C	105 - 130 °C	135 - 150 °C	155 - 230 °C

Get to know how to cook quickly				
Use the automatic programmes to prepare a dish quickly with the default settings:				
Assisted Cooking	Step 1	Step 2	Step 3	Step 4
	Press:  .	Press:  .	Press:  Assisted Cooking.	Choose the dish.

Use quick functions to set the cooking time	
10% Finish assist Use 10% Finish assist to add extra time when 10% of the cooking time is left.	To extend the cooking time press +1min.

Clean the oven with Steam cleaning	
Step 1	Step 2
Press: 	Press: 
Step 3	Choose the mode:
Steam Cleaning	For light cleaning.
Steam Cleaning Plus	For thorough cleaning.
Descaling	For cleaning the steam generation circuit from residual limestone.

Clean the oven with Steam cleaning	
Rinsing	For rinsing and cleaning the steam generation circuit after frequent use of the steam functions.

16. TAKE A SHORTCUT!

Here you can see all the useful shortcuts. You can also find them in the dedicated chapters in the user manual.

How to set: Heating functions



How to set: Steamify - Cooking with a steam heating function



How to set: SousVide Cooking



How to set: Assisted cooking



How to set: Cooking time



How to delay: Start and end of cooking

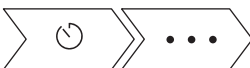

TAKE A SHORTCUT!



How to cancel: Set Timer



How to use: Food Sensor



17. ENVIRONMENTAL CONCERNS

Recycle materials with the symbol . Put the packaging in relevant containers to recycle it. Help protect the environment and human health by recycling waste of electrical and electronic appliances. Do not dispose of appliances marked with the symbol  with the household waste. Return the product to your local recycling facility or contact your municipal office.

www.aeg.com/shop



OK

867371302-A-082022

AEG