

▶ DPB3932S
DPB3632S

EN **User Manual**
Cooker Hood

USER MANUAL

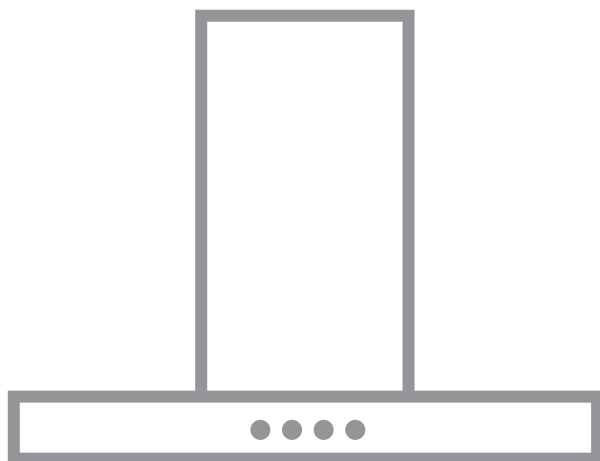

AEG

CONTENTS

1. SAFETY INFORMATION AND INSTALLATION.....	2
2. PRODUCT DESCRIPTION.....	3
3. DAILY USE.....	3
4. CARE AND CLEANING.....	4
5. ENVIRONMENTAL CONCERNS.....	5

FOR PERFECT RESULTS

Thank you for choosing this AEG product. We have created it to give you impeccable performance for many years, with innovative technologies that help make life simpler – features you might not find on ordinary appliances. Please spend a few minutes reading to get the very best from it.

Visit our website to:



Get usage advice, brochures, trouble shooter, service and repair information:
www.aeg.com/support



Register your product for better service:
www.registeraeg.com



Buy Accessories, Consumables and Original spare parts for your appliance:
www.aeg.com/shop

CUSTOMER CARE AND SERVICE

Always use original spare parts.

When contacting our Authorised Service Centre, ensure that you have the following data available: Model, PNC, Serial Number.

The information can be found on the rating plate.

 Warning / Caution-Safety information

 General information and tips

 Environmental information

Subject to change without notice.

1. SAFETY INFORMATION AND INSTALLATION



WARNING!

Refer to the separate Installation Instructions booklet for Safety Information and Installation. Read carefully the Safety chapters before any use or maintenance of the appliance.

2. PRODUCT DESCRIPTION

2.1 Control panel overview



Function	Description
1 First Speed	The fan switches to first speed level.
2 Second Speed	The fan switches to second speed level.
3 Third Speed	The fan switches to third speed level.
4 Lamp	Turns the lights on and off.

3. DAILY USE

3.1 Using the hood

Check the recommended speed according to the table below.

0 1	While heating up food, cooking with covered pots.
2	While cooking with covered pots on multiple cooking zones or burners, gentle frying.
3	While boiling and frying big quantities of food without a lid, cooking on multiple cooking zones or burners.

i It is recommended to leave the hood operating for approximately 15 minutes after cooking.

To operate the hood:

1. Pull out the drawer of the hood more than 5 cm.

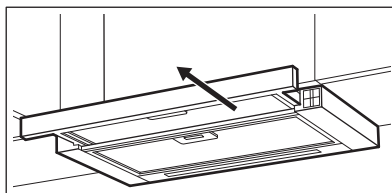

- The control panel is exposed.
2. To activate the function press the **0|1** button.
 3. If needed, change the speed by pressing the desired button.

i The hood light works independently to other hood functions. To illuminate the cooking surface press the light button . Closing the drawer has no effect on the hood light.

i The hood remembers last setting of fan speed on closing the drawer. The hood will operate on this fan speed level when drawer is pulled out again.

To turn off the fan press **0|1** or close the hood drawer.

4. CARE AND CLEANING

4.1 Notes on cleaning



Cleaning Agents

Do not use abrasive detergents and brushes.

Clean the surface of the appliance with a soft cloth with warm water and a mild detergent.

After cooking some parts of appliance can get hot. To avoid stains appliance must be cooled down and dried with clean cloth or paper towels.

Clean stains with a mild detergent.



Keep the hood clean

Clean the appliance and grease filters each month. Clean the interior and grease filters carefully from fat. Fat accumulation or other residue may cause fire.

Grease filters can be washed in a dishwasher.

The dishwasher must be set to a low temperature and a short cycle. The grease filter may discolour, it has no influence on the performance of the appliance.



Charcoal filter

The time of saturation of the charcoal filter varies depending on the type of cooking and the regularity of cleaning the grease filter. The activated charcoal filter is not washable, cannot be regenerated and must be replaced approximately every 4/6 months of operation, or more frequently for particularly heavy usage.

4.2 Cleaning the grease filter

Filters are mounted with the use of clips and pins on the opposite side.

To clean the filter:

1. Press the handle of the mounting clip on the filter panel underneath the hood (1).

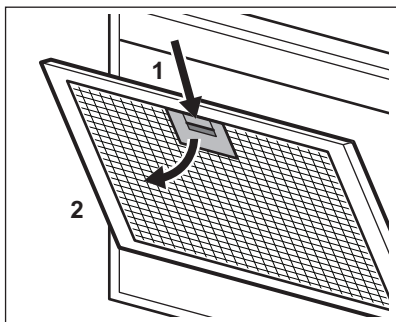

2. Slightly tilt the front of the filter downwards (2), then pull.
- Repeat the first two steps for all filters.
3. Clean the filters using a sponge with non abrasive detergents or in a dishwasher.

i The dishwasher must be set to a low temperature and a short cycle. The grease filter may discolour, it has no influence on the performance of the appliance.

4. To mount the filters back follow the first two steps in reverse order. Repeat the steps for all filters if applicable.

4.3 Replacing the charcoal filter



WARNING!
The charcoal filter is NON-washable! The filter cannot be regenerated!

To replace the charcoal filter:

1. Remove the grease filters from the appliance. Refer to "Cleaning the grease filter" in this chapter.
2. Turn the filter counterclockwise (1) and then pull (2).

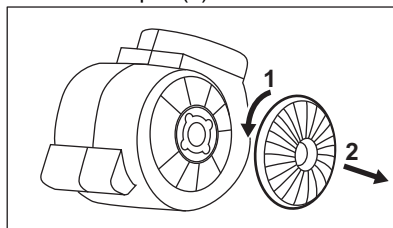

To mount the filters back follow the steps in reverse order.

In any case, it is necessary to replace the filters at least every four months.

4.4 Replacing the lamp

This appliance is supplied with a LED lamp and separate control gear (LED driver). These parts can be replaced by a technician only. In case of any malfunction refer to "Service" in the "Safety Instructions" chapter.

5. ENVIRONMENTAL CONCERNS

Recycle materials with the symbol . Put the packaging in relevant containers to recycle it. Help protect the environment and human health by recycling waste of electrical and electronic appliances. Do not dispose of

appliances marked with the symbol  with the household waste. Return the product to your local recycling facility or contact your municipal office.

www.aeg.com/shop



OK

867351645-B-042022

AEG