

▶ DVE5671HR
DVE5971HR

EN **User Manual**
Cooker Hood

USER MANUAL

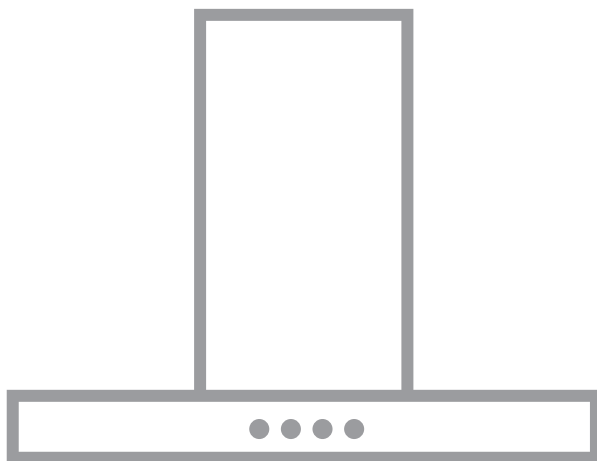

AEG

CONTENTS

1. SAFETY INFORMATION AND INSTALLATION.....	2
2. PRODUCT DESCRIPTION.....	3
3. DAILY USE.....	3
4. CARE AND CLEANING.....	5
5. ENVIRONMENTAL CONCERNS.....	6

FOR PERFECT RESULTS

Thank you for choosing this AEG product. We have created it to give you impeccable performance for many years, with innovative technologies that help make life simpler – features you might not find on ordinary appliances. Please spend a few minutes reading to get the very best from it.

Visit our website to:



Get usage advice, brochures, trouble shooter, service and repair information:
www.aeg.com/support



Register your product for better service:
www.registeraeg.com



Buy Accessories, Consumables and Original spare parts for your appliance:
www.aeg.com/shop

CUSTOMER CARE AND SERVICE

Always use original spare parts.

When contacting our Authorised Service Centre, ensure that you have the following data available: Model, PNC, Serial Number.

The information can be found on the rating plate.

 Warning / Caution-Safety information

 General information and tips

 Environmental information

Subject to change without notice.

1. SAFETY INFORMATION AND INSTALLATION



WARNING!

Refer to the separate Installation Instructions booklet for Safety Information and Installation. Read carefully the Safety chapters before any use or maintenance of the appliance.

2. PRODUCT DESCRIPTION

2.1 Control panel overview

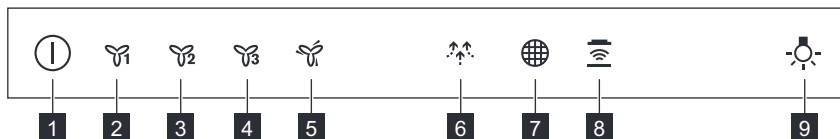

	Function	Description
1	On / Off	Turns the hood on and off.
2	First speed	The motor switches to first speed level.
3	Second speed	The motor switches to second speed level.
4	Third speed	The motor switches to third speed level.
5	Maximum speed	The motor switches to maximum speed level.
6	Breeze	The hood operates on the lowest speed. After 60 minutes the appliance turns off.
7	Filter notification	Reminds to change or clean the charcoal filter and clean the grease filter.
8	Hob ² Hood	Indicator of the function to control hood from hob.
9	Lamp	Turns the lights on and off.

3. DAILY USE

3.1 Using the hood

Check the recommended speed according to the table below.

	While heating up food, cooking with covered pots.
	While cooking with covered pots on multiple cooking zones or burners, gentle frying.
	While boiling and frying big quantities of food without a lid, cooking on multiple cooking zones or burners.
	While boiling and frying big quantities of food without a lid, big humidity.
	Refreshes the air in kitchen after cooking at a very low noise level. It can be activated and de-activated by touching the symbol. The function turns off automatically after 60 minutes. Use after cooking only.

 It is recommended to leave the hood operating for approximately 15 minutes after cooking.

 The control Panel is a sensor field. Touch the symbols for 1 second to activate the functions.

To operate the hood:

1. Turn on the appliance by pressing the  symbol.

You can now activate the functions.

2. To activate the function touch the symbol.
3. If needed, touch the light symbol  to illuminate the cooking surface.

To turn off the appliance press the  symbol again.

3.2 Hob²Hood function



It is an automatic function which connects the hob with a hood. Both the hob and the hood have an infrared signal communicator. Speed of the fan is defined automatically on basis of mode setting and temperature of the hottest cookware on the hob. You can also operate the fan using the hob manually. The function can be activated from panel of the hob.

 For more information how to use the function refer to the hob user manual.



3.3 Activating Maximum Motor Speed

When you touch , the Maximum Motor Speed starts to operate for 8

minutes. After that time, the appliance returns to its previous speed settings.

 When the function is turned on, additional touch on  does not have any effects.

3.4 Filter notification

Filter alarm reminds to change or clean the charcoal filter and clean the grease filter. The filter indicator  is turned on (red) for 30 seconds if the grease filter must be cleaned. The filter indicator  flashes (red) for 30 seconds if the charcoal filter must be replaced or cleaned.

 Refer to cleaning the grease filter in care and cleaning chapter.

 Refer to cleaning the charcoal filter or replacing the charcoal filter in care and cleaning chapter.

To reset the function touch  for 3 seconds.

To activate or deactivate function:

1. Switch on the control panel.
2. Make sure that the icons are turned white.

3. To activate function touch  for 3 seconds.

If the function is activated, the filter icon  flashes (red) five times.

4. To deactivate function touch  for 3 seconds.

If the function is deactivated, the filter icon  flashes (red) three times.

4. CARE AND CLEANING

4.1 Notes on cleaning



Cleaning Agents

Do not use abrasive detergents and brushes.

Clean the surface of the appliance with a soft cloth with warm water and a mild detergent.

After cooking some parts of appliance can get hot. To avoid stains appliance must be cooled down and dried with clean cloth or paper towels.

Clean stains with a mild detergent.



Keep the hood clean

Clean the appliance and grease filters each month. Clean the interior and grease filters carefully from fat. Fat accumulation or other residue may cause fire.

Follow the instructions for cleaning the accessories when filter notification is on. Refer to Filter notification in daily use chapter.

Grease filters can be washed in a dishwasher.

The dishwasher must be set to a low temperature and a short cycle.

The grease filter may discolour, it has no influence on the performance of the appliance.



Charcoal filter

The time of saturation of the charcoal filter varies depending on the type of cooking and the regularity of cleaning the grease filter.

4.2 Cleaning the grease filter

Filters are mounted with the use of clips and pins on the opposite side.

To clean the filter:

1. Pull the cover to open it.

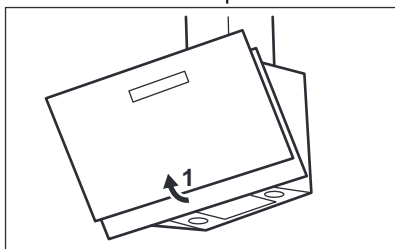

2. Press the handle of the mounting clip on the filter panel underneath the hood (1).

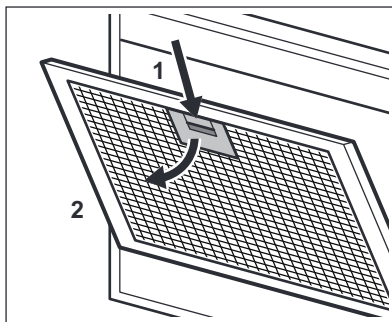

3. Slightly tilt the front of the filter downwards (2), then pull.
4. Clean the filters using a sponge with non abrasive detergents or in a dishwasher.



The dishwasher must be set to a low temperature and a short cycle. The grease filter may discolour, it has no influence on the performance of the appliance.

5. To mount the filters back follow the first two steps in reverse order.

Repeat the steps for all filters if applicable.

4.3 Replacing the charcoal filter

The charcoal filter must be replaced if the filter alarm is on.



Refer to the filter notification in daily use chapter for more information about function.



WARNING!

The charcoal filter is **NON-washable!** The filter cannot be regenerated!

To replace the charcoal filter:

1. Remove the grease filters from the appliance. Refer to "Cleaning the grease filter" in this chapter.
2. Turn the filter counterclockwise (1) and then pull (2).

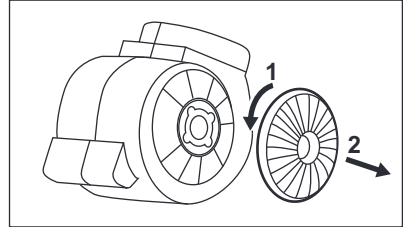

To mount the filters back follow the steps in reverse order.

4.4 Replacing the lamp

This appliance is supplied with a LED lamp and separate control gear (LED driver). These parts can be replaced by a technician only. In case of any malfunction refer to "Service" in the "Safety Instructions" chapter.

5. ENVIRONMENTAL CONCERNS

Recycle materials with the symbol . Put the packaging in relevant containers to recycle it. Help protect the environment and human health by recycling waste of electrical and electronic appliances. Do not dispose of

appliances marked with the symbol with the household waste. Return the product to your local recycling facility or contact your municipal office.

www.aeg.com/shop



867351966-A-072023

AEG