

USER MANUAL



CONTENTS

1. SAFETY INFORMATION.....	2
2. SAFETY INSTRUCTIONS.....	5
3. INSTALLATION.....	7
4. PRODUCT DESCRIPTION.....	14
5. DAILY USE.....	15
6. HINTS AND TIPS.....	19
7. CARE AND CLEANING.....	21
8. TROUBLESHOOTING.....	23
9. TECHNICAL DATA.....	25
10. ENERGY EFFICIENCY.....	26

FOR PERFECT RESULTS

Thank you for choosing this AEG product. We have created it to give you impeccable performance for many years, with innovative technologies that help make life simpler – features you might not find on ordinary appliances. Please spend a few minutes reading to get the very best from it.

Visit our website to:



Get usage advice, brochures, trouble shooter, service and repair information:
www.aeg.com/support



Register your product for better service:
www.registeraeg.com



Buy Accessories, Consumables and Original spare parts for your appliance:
www.aeg.com/shop

CUSTOMER CARE AND SERVICE

Always use original spare parts.

When contacting our Authorised Service Centre, ensure that you have the following data available: Model, PNC, Serial Number.

The information can be found on the rating plate.

 Warning / Caution-Safety information

 General information and tips

 Environmental information

Subject to change without notice.

1. SAFETY INFORMATION

Before the installation and use of the appliance, carefully read the supplied instructions. The manufacturer is not responsible for any injuries or damages that are the result of incorrect installation or usage. Always keep the

instructions in a safe and accessible location for future reference.

1.1 Children and vulnerable people safety

- This appliance can be used by children aged from 8 years and above and persons with reduced physical, sensory or mental capabilities or lack of experience and knowledge if they have been given supervision or instruction concerning the use of the appliance in a safe way and understand the hazards involved.
- Children between 3 and 8 years of age and persons with very extensive and complex disabilities shall be kept away unless continuously supervised.
- Children of less than 3 years of age should be kept away unless continuously supervised.
- Do not let children play with the appliance.
- Keep all packaging away from children and dispose of it appropriately.
- Keep children and pets away from the appliance when it operates or when it cools down. Accessible parts are hot.
- If the appliance has a child safety device, it should be activated.
- Children shall not carry out cleaning and user maintenance of the appliance without supervision.



1.2 General Safety

- **WARNING:** The appliance and its accessible parts become hot during use. Care should be taken to avoid touching heating elements.
- Do not operate the appliance by means of an external timer or separate remote-control system.
- **WARNING:** Unattended cooking on a hob with fat or oil can be dangerous and may result in fire.
- **NEVER** try to extinguish a fire with water, but switch off the appliance and then cover flame e.g. with a lid or a fire blanket.

- **CAUTION:** The cooking process has to be supervised. A short term cooking process has to be supervised continuously.
- **WARNING:** Danger of fire: Do not store items on the cooking surfaces.
- Metallic objects such as knives, forks, spoons and lids should not be placed on the hob surface since they can get hot.
- Do not use a steam cleaner to clean the appliance.
- If the glass ceramic surface / glass surface is cracked, switch off the appliance and unplug it from the mains. In case the appliance is connected to the mains directly using junction box, remove the fuse to disconnect the appliance from power supply. In either case contact the Authorised Service Centre.
- In case of hotplate glass breakage:
 - shut immediately off all burners and any electrical heating element and isolate the appliance from the power supply,
 - do not touch the appliance surface,
 - do not use the appliance.
- If the supply cord is damaged, it must be replaced by the manufacturer, an authorized Service or similarly qualified persons in order to avoid a hazard.
- Where the appliance is directly connected to the power supply, an all-pole isolating switch with a contact gap is required. Complete disconnection in compliance with the conditions specified in overvoltage category III must be guaranteed. The earth cable is excluded from this.
- When you route the mains cable, make sure that the cable doesn't come into direct contact (for example using insulating sleeving) with parts that can reach temperatures of more than 50°C above room temperature.
- **WARNING:** Use only hob guards designed by the manufacturer of the cooking appliance or indicated by the manufacturer of the appliance in the instructions

for use as suitable or hob guards incorporated in the appliance. The use of inappropriate guards can cause accidents.

2. SAFETY INSTRUCTIONS

This appliance is suitable for the following markets:  

2.1 Installation



WARNING!

Only a qualified person must install this appliance.



WARNING!

Risk of injury or damage to the appliance.

- Remove all the packaging.
- Do not install or use a damaged appliance.
- Follow the installation instructions supplied with the appliance.
- Keep the minimum distance from other appliances and units.
- Always take care when moving the appliance as it is heavy. Always use safety gloves and enclosed footwear.
- Seal the cut surfaces with a sealant to prevent moisture to cause swelling.
- Protect the bottom of the appliance from steam and moisture.
- Do not install the appliance adjacent to a door or under a window. This prevents hot cookware falling from the appliance when the door or the window is opened.
- If the appliance is installed above drawers make sure that the space, between the bottom of the appliance and the upper drawer, is sufficient for air circulation.
- The underside of the appliance can get hot when in use. If an oven has not been fitted underneath the hob and underside of the appliance is accessible and could allow a user or items stored beneath the hob to come in direct contact with the underside of the hob, an intermediate protection panel must be fitted.

- Plywood or kitchen carcass material is acceptable for the panel.
- The panel must be removable for servicing. Screws used to fix the panel must be accessible after installation.

2.2 Electrical Connection



WARNING!

Risk of fire and electric shock.

- All electrical connections should be made by a qualified electrician.
- The appliance must be earthed.
- Before carrying out any operation make sure that the appliance is disconnected from the power supply.
- Make sure that the parameters on the rating plate are compatible with the electrical ratings of the mains power supply.
- Make sure the appliance is installed correctly. Loose and incorrect electricity mains cable or plug (if applicable) can make the terminal become too hot.
- Use the correct electricity mains cable.
- Do not let the electricity mains cable tangle.
- Make sure that a shock protection is installed.
- Use the strain relief clamp on the cable.
- Make sure the mains cable or plug (if applicable) does not touch the hot appliance or hot cookware, when you connect the appliance to the near sockets.
- Do not use multi-plug adapters and extension cables.
- Make sure not to cause damage to the mains plug (if applicable) or to the mains cable. Contact our Authorised Service Centre or an electrician to change a damaged mains cable.

- The shock protection of live and insulated parts must be fastened in such a way that it cannot be removed without tools.
- Connect the mains plug to the mains socket only at the end of the installation. Make sure that there is access to the mains plug after the installation.
- If the mains socket is loose, do not connect the mains plug.
- Do not pull the mains cable to disconnect the appliance. Always pull the mains plug.
- Use only correct isolation devices: line protecting cut-outs, fuses (screw type fuses removed from the holder), earth leakage trips and contactors.
- The electrical installation must have an isolation device which lets you disconnect the appliance from the mains at all poles. The isolation device must have a contact opening width of minimum 3 mm.

2.3 Gas connection

- All gas connections should be made by a qualified person.
- Before installation, make sure that the local distribution conditions (nature of the gas and gas pressure) and the adjustment of the appliance are compatible.
- Make sure that there is air circulation around the appliance.
- The information about the gas supply is on the rating plate.
- This appliance is not connected to a device, which evacuates the products of combustion. Make sure to connect the appliance according to current installation regulations. Pay attention to requirements regarding adequate ventilation.

2.4 Use



WARNING!
Risk of injury, burns and electric shock.

- Remove all the packaging, labelling and protective film (if applicable) before first use.
- This appliance is for household use only.

- Do not change the specification of this appliance.
- Make sure that the ventilation openings are not blocked.
- Do not let the appliance stay unattended during operation.
- Set the cooking zone to "off" after each use.
- Do not put cutlery or saucepan lids on the cooking zones. They can become hot.
- Do not operate the appliance with wet hands or when it has contact with water.
- Do not use the appliance as a work surface or as a storage surface.
- When you place food into hot oil, it may splash.



WARNING!
Risk of fire and explosion

- Fats and oil when heated can release flammable vapours. Keep flames or heated objects away from fats and oils when you cook with them.
- The vapours that very hot oil releases can cause spontaneous combustion.
- Used oil, that can contain food remnants, can cause fire at a lower temperature than oil used for the first time.
- Do not put flammable products or items that are wet with flammable products in, near or on the appliance.



WARNING!
Risk of damage to the appliance.

- Do not keep hot cookware on the control panel.
- Do not let cookware to boil dry.
- Be careful not to let objects or cookware fall on the appliance. The surface can be damaged.
- Do not activate the cooking zones with empty cookware or without cookware.
- Do not put aluminium foil on the appliance.
- Cookware made of cast iron, aluminium or with a damaged bottom can cause scratches on the glass / glass ceramic. Always lift these objects up when you have to move them on the cooking surface.

- Use only stable cookware with the correct shape and diameter larger than the dimensions of the burners.
- Make sure cookware is centrally positioned on the burners.
- Do not use large cookware that overlap the edges of the appliance. This can cause damage to the worktop surface.
- Use only the accessories supplied with the appliance.
- Do not install a flame diffuser on the burner.
- The use of a gas cooking appliance results in the production of heat and moisture. Provide good ventilation in the room where the appliance is installed.
- Prolonged intensive use of the appliance may call for additional ventilation, for example opening of a window, or more effective ventilation, for example increasing the level of mechanical ventilation where present.
- This appliance is for cooking purposes only. It must not be used for other purposes, for example room heating.
- Do not let acid liquids, for example vinegar, lemon juice or limescale remover, touch the hob. This can cause matt patches.
- Discoloration of the enamel or stainless steel has no effect on the performance of the appliance.

2.5 Care and cleaning

- Clean the appliance regularly to prevent the deterioration of the surface material.
- Deactivate the appliance and let it cool down before you clean it.
- Disconnect the appliance from the electrical supply before maintenance.

- Do not use water spray and steam to clean the appliance.
- Clean the appliance with a moist soft cloth. Only use neutral detergents. Do not use any abrasive products, abrasive cleaning pads, solvents or metal objects.
- Do not clean the burners in the dishwasher.

2.6 Service

- To repair the appliance contact the Authorised Service Centre. Use original spare parts only.
- Concerning the lamp(s) inside this product and spare part lamps sold separately: These lamps are intended to withstand extreme physical conditions in household appliances, such as temperature, vibration, humidity, or are intended to signal information about the operational status of the appliance. They are not intended to be used in other applications and are not suitable for household room illumination.

2.7 Disposal



WARNING!

Risk of injury or suffocation.

- Contact your municipal authority for information on how to discard the appliance correctly.
- Disconnect the appliance from the mains supply.
- Cut off the mains electrical cable close to the appliance and dispose of it.
- Flat the external gas pipes.

3. INSTALLATION



WARNING!

Refer to Safety chapters.

3.1 Before the installation

Before you install the hob, write down the information bellow from the rating plate.

The rating plate is on the bottom of the hob.

Model

PNC

Serial number

3.2 Important safety requirements

This hob must be installed in accordance with the Gas Safety (Installation and Use) Regulations (Current Edition) and the IEE Wiring Regulations (Current Edition).

For appliances installed in the Republic of Ireland please refer to NSAI- Domestic Gas Installation I.S. 813 Current Editions and the ETCI Rules for Electrical Installations.

Provision for ventilation

Detailed recommendations are contained in the following British Standards Codes Of Practice: B.S. 6172/B.S. 5440, Par. 2 and B.S. 6891 Current Editions.

The hob should not be installed in a bed sitting room with a volume of less than 20 m³. If it is installed in a room of volume less than 5 m³ an air vent of effective area of 100 cm² is required. If it is installed in a room of volume between 5 m³ and 10 m³ an air vent of effective area of 50 cm² is required, while if the volume exceeds 11 m³ no air vent is required.

However, if the room has a door which opens directly to the outside no air vent is required even if the volume is between 5 m³ and 11 m³.

If there are other fuel burning appliances in the same room, B.S. 5440 Part 2 Current Edition, should be consulted to determine the requisite air vent requirements.

For appliances installed in the Republic of Ireland please refer to the NSAI- Domestic Gas Installation I.S. 813 Current Editions Table Four.

Location

The hob may be located in a kitchen, a kitchen/diner or bed sitting room (with a volume greater than 20 m³), but not in a bathroom or shower room.

The minimum distance combustible material can be fitted above the hob in line with the edges of the hob is 400 mm. If it is fitted below 400 mm a space of 50 mm must be allowed from the edges of the hob.

For appliances installed in the Republic of Ireland please refer to NSAI- Domestic Gas Installation I.S 813 Current Edition Section 7- Permitted Locations of Appliance.

3.3 Gas Connection



WARNING!

Any gas installation must be carried out by a GAS SAFE REGISTER installer.

Make sure that, once the hob is installed, it is easily accessible for the engineer in the event of a breakdown.

The manufacturer will not accept liability, should the above instructions or any of the other safety instructions incorporated in this instruction booklet be ignored.

On the end of the shaft, which includes the R 1/2" threaded elbow, adjustment is fixed so that the washer is fitted between the components as shown in the diagram. Screw the parts together without using excessive force.

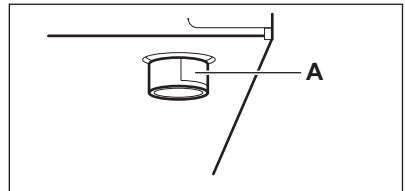

A. End of shaft with nut

Connection to the gas supply should be with either rigid or semi-rigid pipe, i.e. steel or copper.

The connection should be suitable for connecting to R 1/2 (1/2 BSP male thread).

When the final connection has been made, it is essential that a thorough leak test is carried out on the hob and installation.

Make sure that the main connection pipe does not exert any strain on the hob.

If you use flexible metal pipes make sure that they agree to ISO 10380 and ISO 10807 standards. Be careful they do not come in touch with mobile parts or they

are not squeezed. Also be careful when the hob is put together with an oven.



CAUTION!

It is important to install the elbow correctly, with the shoulder on the end of the thread, fitted to the hob connecting pipe.



CAUTION!

Failure to ensure the correct assembly will cause leakage of gas.



CAUTION!

Make sure that the gas supply pressure of the appliance obeys the recommended values.

Rigid connection:

Carry out connection by using metal rigid pipes (copper with mechanical end).







3.4 Injectors replacement

1. Remove the pan supports.
2. Remove the caps and crowns of the burner.
3. With a socket spanner 7 remove the injectors and replace them with the ones which are necessary for the type of gas you use (see table in "Technical Data" chapter).

4. Assemble the parts, follow the same procedure backwards.
5. Replace the rating plate (it is near the gas supply pipe) with the one for the new type of gas supply. You can find this plate in the package supplied with the appliance.

If the supply gas pressure is changeable or different from the necessary pressure, you must fit an applicable pressure adjuster on the gas supply pipe.

3.5 Gas selection

1. Touch  for 3 seconds.
2. Within 7 seconds, touch  for 3 seconds.
3. Touch  3 times.
The display shows G1 mode.
4. Touch .
To enter the mode.
5. Timer display shows selected gas type.
6. Touch  to set the gas type according to table below.
7. Touch .
To confirm the gas type.

Touch  to exit the mode or wait for Automatic Switch Off function activates.

Gas selection		
0	1	2
G20 20 mbar	Liquid gas 29 mbar	Safety risk, do not use 2 gas selection. Use only 0 or 1 gas selections depend on gas supply.

3.6 Adjustment of minimum level







WARNING!

Information for authorised installer only.





Switch off the hob before the adjustment.

To adjust the minimum level of the burners:

1. Touch  for 3 seconds.
2. Within 7 seconds, touch  for 3 seconds.
3. Touch  4 times.
The display shows G2 mode.
4. Touch .
To enter the mode.
5. Wait 5 seconds, after selecting the mode.

The burner shows minimum level and the control bar shows .

6. Touch  or .

To increase or decrease the value and adjust the minimum level.

7. Wait 5 seconds.

To send the selected value to power board.

8. Check it the minimum level is correct and touch .

To confirm the minimum level.



If the minimum level is incorrect, repeat the steps 6 and 7.

9. Touch  to select the next burner and repeat the steps 5-8.

Touch  to exit the mode.



WARNING!

Make sure the flame does not go out when you move quickly from the maximum to the minimum heat setting position.



WARNING!

Do not set the G3 and G4 modes. It is for authorised installer only.

3.7 Electrical connection

- Do not pull the mains cable to disconnect the appliance. Always pull the mains plug (if applicable).
- The appliance must not be connected with an extension cable, an adapter or a multiple socket. There is a risk of fire.
- Do not let the power cable to heat up to a temperature of more than 90° C. The cable should be guided by means of clamps fixed to the side of the cabinet, in order to avoid any contact with the appliance beneath the cooktop.
- Make sure that there is access to the mains plug after the installation.

Electrical Requirements

Permanent electrical installation must agree with the latest I.E.E. Regulations and local Electricity Board regulations. For your own safety the installation must

be done by a qualified electrician (e.g. your local Electricity Board, or a contractor who is on the roll of the National Inspection Council for Electrical Installation Contracting [NICEIC]).



The manufacturer refuses to be held responsible, if these safety measures are not abided by.

Supply connections

This hob has to be connected to 220-240 V (~ 50-60 Hz) electricity supply.

The hob has a terminal block which is marked as follows:

- **L** — Live terminal
- **N** — Neutral terminal
-  or **E** — Earth terminal

Before carrying out the connection, make sure:

1. The limiter valve and the electrical system can take the appliance load (see the rating plate)
2. The supply system is equipped with an efficient earth connection in compliance with the current standards and regulations
3. The outlet or omnipolar switch used for connection is easily accessible with the appliance installed.

The appliance is supplied with a 3 core flexible power cable.

The wires in the cord are coloured as follows:

Green and yellow	- Earth
Blue	- Neutral
Brown	- Live



WARNING!

A cut off plug inserted into a 13 amp socket is a serious shock hazard. Ensure that the cut off plug is disposed of safely.

3.8 Replacement of the connection cable

i The replacement of electric cable must be carried out exclusively by the service force centre or by personnel with similar competencies, in accordance with the current regulations.

i To replace the connection cable use only H05SS-F T180 or equivalent type. Make sure that the cable section is applicable to the voltage load and the working temperature. The yellow/green earth wire (B) must be approximately 2 cm longer than the live and neutral wire (A).

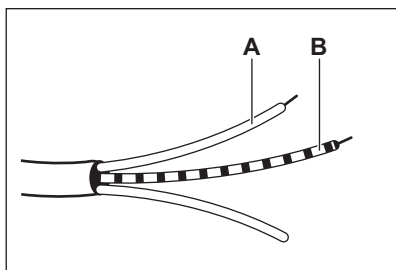

1. Connect the green and yellow (earth) wire to the terminal which is marked with the letter 'E', or the earth symbol \oplus , or coloured green and yellow.
2. Connect the blue (neutral) wire to the terminal which is marked with the letter 'N' or coloured blue.
3. Connect the brown (live) wire to the terminal which is marked with the letter 'L'. It must always be connected to the network phase. There must be no cut or stray strands of wire present. The cord clamp must be correctly attached to the outer sheath.

3.9 Assembly

1.

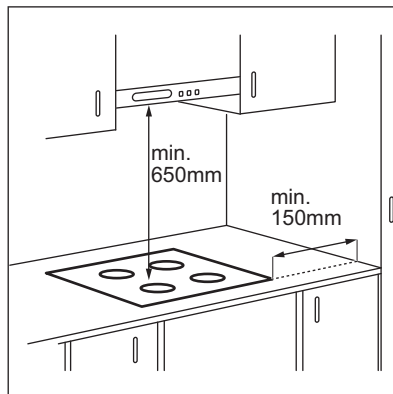

2.

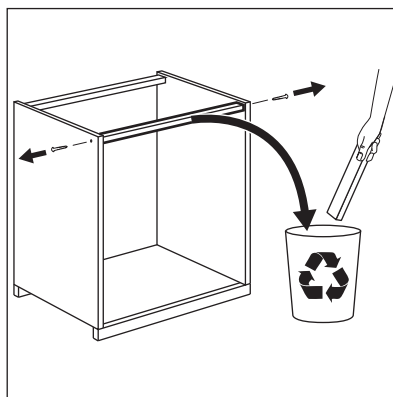

3.

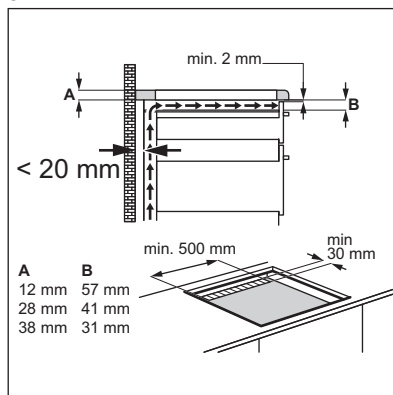

4.

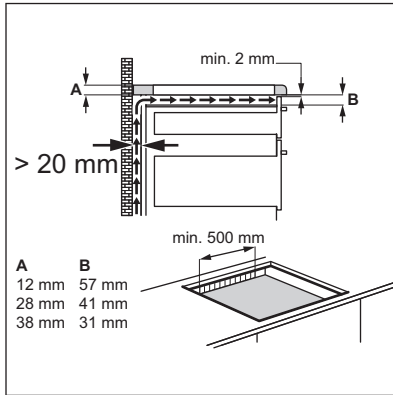

5.

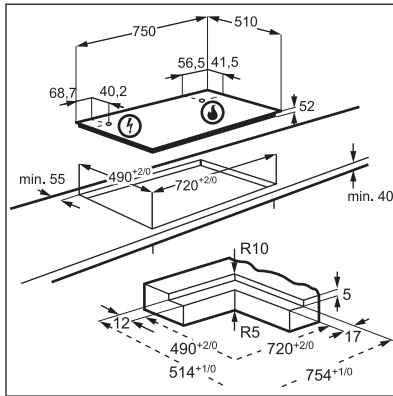

6.

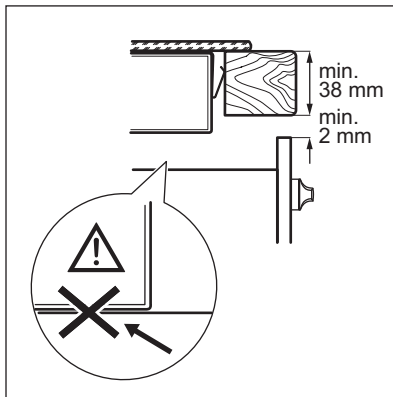

7.

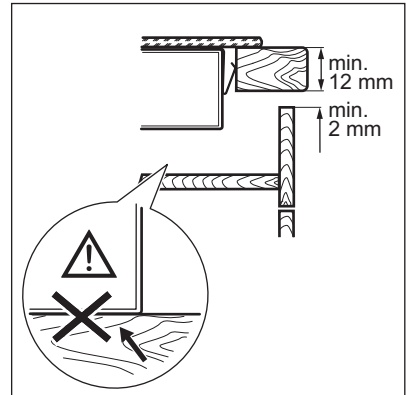

8.

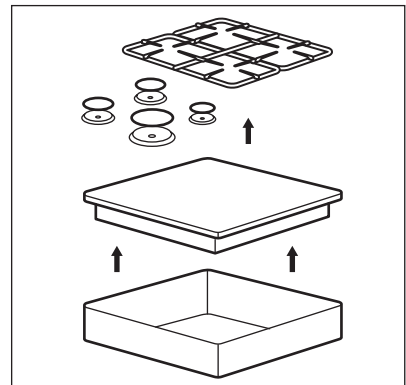

9.

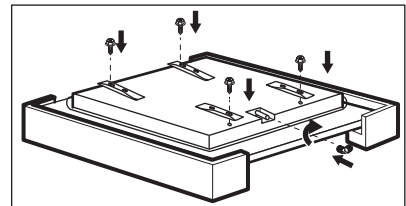

10.

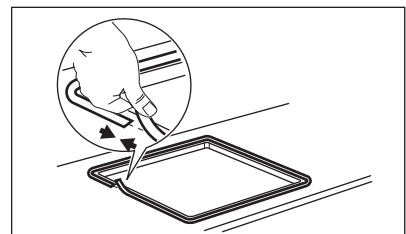

11.

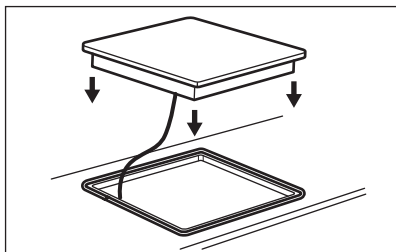

12.

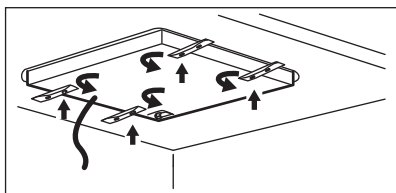

13.

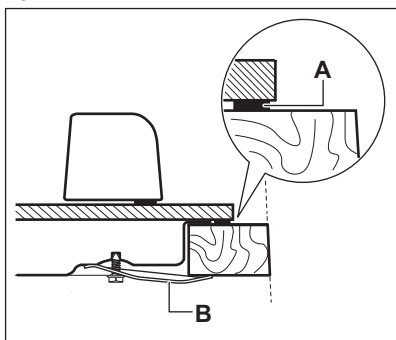

- A. Supplied seal
B. Supplied bracket

14.

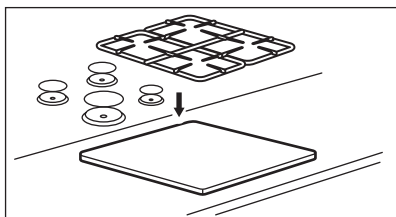

CAUTION!
Install the appliance only on
a worktop with flat surface.

3.10 Installing hob under the hood



If you install the hob under a hood, please see the installation instructions of the hood for the minimum distance between the appliances.

3.11 Possibilities for insertion

The panel installed below the hob must be easy to remove and let an easy access in case a technical assistance intervention is necessary.

Kitchen unit with door or drawer

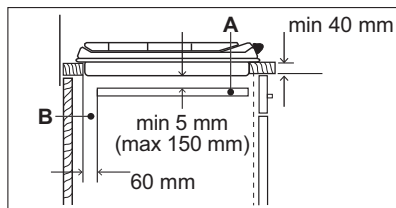
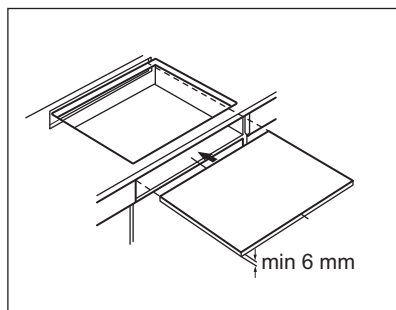

- A. Removable panel
B. Space for connections

Kitchen unit with oven

The electrical connection of the hob and the oven must be installed separately for safety reasons and to let easy remove oven from the unit.

4. PRODUCT DESCRIPTION

4.1 Cooking surface layout

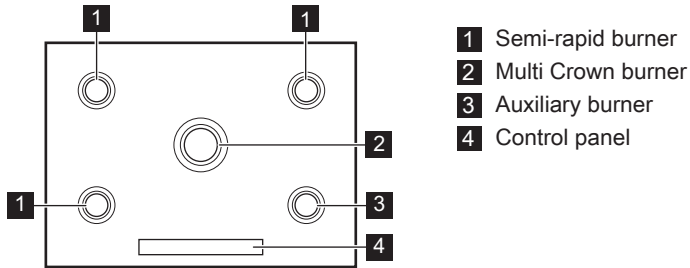

4.2 Control panel layout

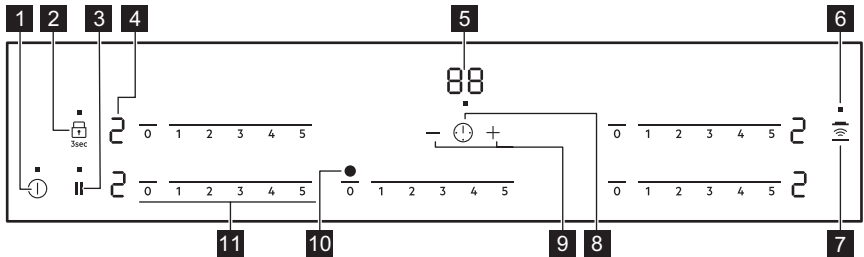







Use the sensor fields to operate the appliance. The displays, indicators and sounds tell which functions operate.

Sensor field	Function	Comment
1	⏻	ON / OFF To activate and deactivate the hob.
2	🔒	Lock / Child Safety Device To lock / unlock the control panel.
3	⏸	Pause To activate and deactivate the function.
4	-	Heat setting display To show the heat setting.
5	-	Timer display To show the time in minutes.
6	■	Led indicator To show activated function.
7	📶	Hob²Hood To activate and deactivate the manual mode of the function.
8	⌚	- To activate and deactivate the Timer.

Sensor field	Function	Comment
9	+ / -	To increase or decrease the time.
10	-	Area for Hob ² Hood infrared signal
11	-	Control bar

4.3 Heat setting displays

Display	Description
	Burner is deactivated.
	Burner operates.
	There is a fault.
	A cooking zone is still hot (residual heat).
	Lock / Child Safety Device operates.
	Pause operates.
	Automatic Switch Off function operates.

4.4 Hot Surface Indicator



WARNING!

If the cooking zone becomes hot during cooking, the setting indicator shows a Hot Surface warning  when the zone is turned off. The Hot Surface Indicator shows until the cooking zone cools.

5. DAILY USE



WARNING!

Refer to Safety chapters.

5.1 Burner overview

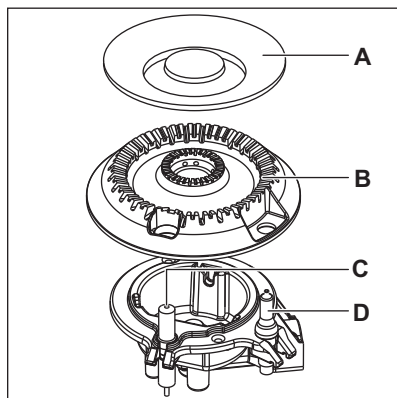
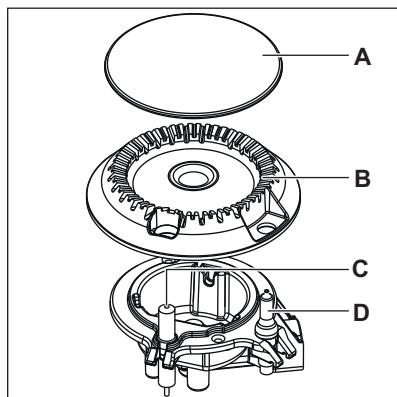

- A. Burner cap
- B. Burner crown
- C. Ignition candle
- D. Flame safety device

5.2 Ignition of the burner

- i** Always light the burner before you put on the cookware.



WARNING!

Be very careful when you use open fire in the kitchen environment. The manufacturer declines any responsibility in case of the flame misuse.

1. Touch  for 1 second to activate the hob.

After 20 seconds of non-use, the hob deactivates.

2. After light animation, when you see  on display, touch the control bar at the correct heat setting or move your finger along the control bar until you reach the correct heat setting. To set or change the heat setting.







If after some tries the burner does not light, check if the crown and its cap are in correct positions and clean the metal part of the flame safety device (Refer to "Care and cleaning") .



If the burner accidentally goes out, the hob re-ignite the burner 3 times. If the flame still does not light,  appears.



If the  appears, deactivate and activate the hob. After light animation, when  reappears, touch  and then  within 3 seconds. When you see  the fault is reset.

5.3 Turning the burner off

To put the flame out, touch the control bar to the off position .



WARNING!

Always turn the flame down or switch it off before you remove the pans from the burner.

5.4 Automatic Switch Off

The function deactivates the hob automatically if:

- all burners are deactivated,
- you do not set the heat setting after you activate the hob,
- you spill something or put something on the control panel for more than 10 seconds (a pan, a cloth, etc.). An acoustic signal sounds and the hob

deactivates. Remove the object or clean the control panel.

- you do not deactivate a burner or change the heat setting. After some time  comes on and the hob deactivates.



The relation between the heat setting and the time after which the hob deactivates:

Level	Time (hours)
1	6
2	3
3	3
4	1,5
5	1,5



5.5 Lock or unlock the cooktop

You can lock the control panel while burners operate. It prevents an accidental change of the heat setting.





To lock the control panel:

1. Set the heat setting.
2. Touch the .
3.  appears on the display of the burner.

To unlock the control panel, touch  again.



-  You can turn the burners off while the control panel is locked. Use  to deactivate the hob.

To set the lock for child safety:



1. Touch  to turn the cooktop on.
2. Touch  for 3 seconds, to activate the lock.  comes on in all control bars.
3. Touch  to turn the cooktop off.

-  You can unlock the cooktop while the child safety operates.

To temporarily unlock:

1. Touch  to turn the cooktop on.
2. Touch  for 3 seconds.
3.  appears on the display of the burner.
4. Set the heat setting.
5. After end of the cooking process and after turning off the cooktop, the Lock function is active.

To completely unlock:

1. Touch  to turn the cooktop on.
2. Touch  for 3 seconds. The lock deactivates.
3. Touch  to turn the cooktop off.

5.6 Pause

This function sets all burners that operate to the lowest heat setting.

When the function operates, you can not change the heat setting.

When the function does not stop the timer functions.





Touch  to activate the function.

 comes on.

To deactivate the function, touch . The previous heat setting comes on.

5.7 Minute Minder

You can use this function as a Minute Minder when the hob is activated.

1. Touch .
2. Touch  or  of the timer to set the time in minutes (00-99). The timer indicator  starts to flash quickly during the time setting.
3. When the timer indicator  starts to flash slowly, the timer is activated.

When the time comes to an end, the sound operates and **00** flashes.





4. Touch .



To stop the sound.

-  The function has no effect on the operation of the burners.

-  The maximum duration of the timer functions is 00-99 minutes. Check the minute minder instructions (missing timer adjustment).

5.8 OffSound Control (Deactivating and activating the sounds)

Deactivate the hob. Touch  for 3 seconds. The display comes on and goes out. Touch  for 3 seconds.  or  comes on. Touch  of the timer to choose one of the following:

-  - the sounds are off
-  - the sounds are on

To confirm your selection wait until the hob deactivates automatically.

When the function is set to  you can hear the sounds only when:

- you touch 
- Minute Minder comes down
- Count Down Timer comes down
- you put something on the control panel.

5.9 Hob²Hood

It is an advanced automatic function which connects the hob to a special hood. Both the hob and the hood have an infrared signal communicator. Speed of the fan is defined automatically on the basis of the mode setting and temperature of the hottest cookware on the hob. You can also operate the fan from the hob manually.

-  The hood operates only when the hob is activated.





-  For most of the hoods, the remote system is originally deactivated. Activate it before you use the function. For more information refer to the hood user manual.



-  The hob automatically sets the speed of the fan according to the cooking process.



Automatic modes

Mode	Mode description	Auto- matic light	Auto- matic fan speed
H0	Manual	Off	Off
H1	Auto light	On	Off
H2	Fixed speed	On	1
H3	Auto speed Low	On	0-1
H4	Auto speed Mid	On	0-1
H5	Auto speed High	On	0-2
H6	Auto speed Intense	On	0-3

Changing the automatic mode

1. Deactivate the appliance.
2. Touch  for 3 seconds. the display comes on and goes off.
3. Touch  for 3 seconds.
4. Touch  a few times until  comes on.
5. Touch  of the Timer to select an automatic mode.

-  Touch  to set the speed manually.

-  Touch longer  to turn off the fan and the light.



WARNING!

After end of cooking, the hood does not turn off automatically. Turn it off manually.

6. HINTS AND TIPS

! **WARNING!**
Refer to Safety chapters.

6.1 Cookware

! **CAUTION!**
Do not use cast iron pans, clay or earthenware pots, grill or toaster plates.

! **WARNING!**
Do not put the same pan on two burners.

! **WARNING!**
Do not put unstable or damaged pots on the burner to prevent spills and injuries.

! **CAUTION!**
Make sure that pot handles are not above the front edge of the cooktop.

! **CAUTION!**
Make sure that the pots are placed centrally on the burner in order to get the maximum stability and a lower gas consumption.

! **CAUTION!**
Liquids spilt during cooking can cause the glass to break.

6.2 Diameters of cookware

i Use cookware with diameters applicable to the size of burners.

Burner	Diameter of cookware (mm)
Multi Crown	220 - 260
Semi-rapid (rear left)	120 - 240
Semi-rapid (rear right)	120 - 240
Semi-rapid (front left)	120 - 220

Burner	Diameter of cookware (mm)
Auxiliary	80 - 180

6.3 Hints and Tips for Hob²Hood

When you operate the hob with the function:

- Protect the hood panel from direct sunlight.
- Do not spot halogen light on the hood panel.
- Do not cover the hob control panel.
- Do not interrupt the signal between the hob and the hood (for example with a hand or a cookware handle). See the picture.

The hood in the picture is only exemplary.

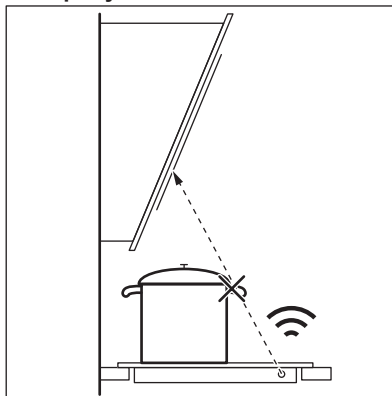

i Keep the window for Hob²Hood infrared signal communicator clean.





i Other remotely controlled appliances may block the signal. Do not use any remotely controlled appliances at the time when you use the function on the hob.

Cooker hoods with the Hob²Hood function

To find the full range of cooker hoods which work with this function refer to our consumer website. The Electrolux cooker hoods that work with this function must have the symbol .

- Each example in the table below shows two or three steps.
- If you use a pan, heat up the oil first, while frying keep the pan at a constant temperature in accordance with the values suggested in the table.









Cooking method symbols used in the table:





	Heat up the oil
	Gentle frying
	Heat to boiling
	Simmering
	Blending, melting ingredients

6.4 Examples of cooking applications

The data in the table shows examples of the heat setting and cooking times for gentle and heavy frying, and delicate cooking.

- Adjust the settings depend on the type of food, the type of the gas used, the material and the size of the pans. Refer to diameters of cookware in Hints and Tips chapter.
- For delicate cooking use the auxiliary burner or semi-rapid burner with flame spreader.
- For an even heat distribution use coated pan and cook on auxiliary or semi-rapid burners.

Food	P or tions	Burner	Step 1			Step 2			Step 3		
			Sym- bol	Le- ve	Time (min)	Sym- bol	Le- ve	Time (min)	Sym- bol	Le- ve	Time (min)
Crepe s	4	SR		5	1-4		2	4-8			
Bur- gers	2	AUX		5	1-5		3	4-8			
Bur- gers	3	SR		5	1-5		3	4-8			
Bur- gers	4	MC		5	1-5		3	4-7			
Fries	4	MC		5	20-30						

Be- cha- mel¹⁾	4	AUX	 2)	1	5-10	 2)	5	5-10	 2)	1	4-8
Rice por- ridg e¹⁾	4	AUX	 2)	5	10-20	 2)	1	30-40			

1) Stirring continuously

2) Without lid

7. CARE AND CLEANING



WARNING!

Refer to Safety chapters.

7.1 General information

- Clean the hob after each use.
- It is recommended to activate the lock / child safety device function (Refer to "Lock or unlock the cooktop" in "Daily use" chapter).
- Always use cookware with a clean base.
- Scratches or dark stains on the surface have no effect on how the hob operates.
- Use a special cleaner suitable for the surface of the hob.



The presence of water or other liquids on the control panel can accidentally activate or deactivate the hob functions.



WARNING!

Do not use knives, scrapers or similar instruments to clean the surface of the glass or the rims of the burners and the frame (if applicable).

- Wash stainless steel parts with water, and then dry them with a soft cloth.

7.2 Pan supports



The pan supports are not resistant to washing in a dishwasher. They must be washed by hand.

1. Remove the pan supports to easily clean the hob.



Be very careful when you replace the pan supports to prevent the hob top from damage.

2. The enamel coating occasionally can have rough edges, so be careful when you wash the pan supports by hand and dry them. If necessary, remove stubborn stains with a paste cleaner.
3. After you clean the pan supports, make sure that they are in correct positions.
4. For the burner to operate correctly, make sure that the arms of the pan supports are aligned with the centre of the burner.

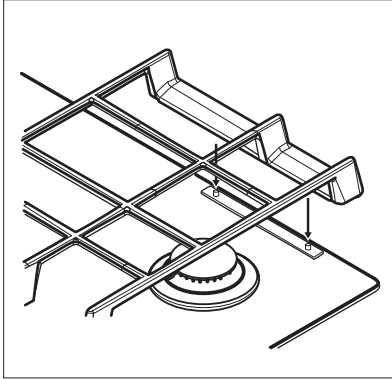

7.3 Removing pan supports

To keep the pan supports in the correct position, they are put on metal pins installed in the rear side of the hob. For easier cleaning, pan supports can be removed from the hob. Lift up the pan supports keeping them in horizontal position as shown in the graphic.



Do not lift the pan supports at an angle, as this will put strain on the metal pins. This can cause damage to the pins and cause them to break.

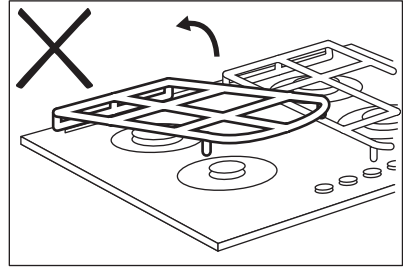
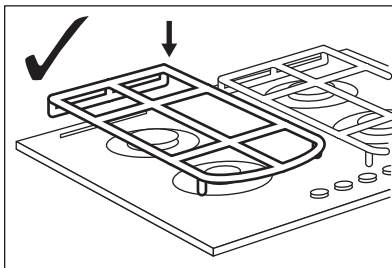
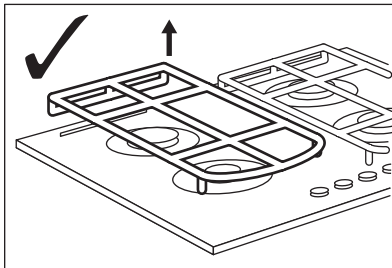

The shape of pan supports and the amount of burners can be different in other models of the appliance.

7.4 Cleaning the hob

- **Remove immediately:** melted plastic, plastic foil, sugar and food with sugar, otherwise, the dirt can cause damage to the hob. Take care to avoid burns.
- **Remove when the hob is sufficiently cool:** limescale rings, water rings, fat stains, shiny metallic discoloration. Clean the hob with a moist cloth and a non-abrasive detergent. After cleaning, wipe the hob dry with a soft cloth.
- To clean the enamelled parts, caps and crowns, wash them with warm soapy water and dry them carefully before you put them back on.

7.5 Cleaning the ignition candle and the flame safety device

Keep the metal part of the ignition candle and the flame safety device cleaned with a moist cloth or sponge to prevent difficult lightning or difficult flame recognition. Check if the burner crown is not blocked with food residues.

7.6 Periodic maintenance



Speak to your local Authorised Service Centre periodically to check the conditions of the gas supply pipe and the pressure adjuster, if fitted.

8. TROUBLESHOOTING



WARNING!
Refer to Safety chapters.

8.1 What to do if...

Problem	Possible cause	Remedy
You cannot activate or operate the hob.	The hob is not connected to an electrical supply or it is connected incorrectly.	Check if the hob is correctly connected to the electrical supply. Refer to the connection diagram.
	The fuse is blown.	Make sure that the fuse is the cause of the malfunction. If the fuse is blown again and again, contact a qualified electrician.
	You do not set the heat setting for 20 seconds.	Activate the hob again and set the heat setting in less than 20 seconds.
	You touched 2 or more sensor fields at the same time.	Touch only one sensor field.
	There is water or fat stains on the control panel.	Clean the control panel.
An acoustic signal sounds and the hob deactivates. An acoustic signal sounds when the hob is deactivated.	You put something on one or more sensor fields.	Remove the object from the sensor fields.
The hob deactivates.	You put something on the sensor field ①.	Remove the object from the sensor field.
Hob ² Hood function does not work.	You covered the control panel.	Remove the object from the control panel.
The sensor fields become hot.	The cookware is too large or you put it too near to the controls.	Put large cookware on the rear burners if possible.
There is no sound when you touch the panel sensor fields.	The sounds are deactivated.	Activate the sounds. Refer to "Daily use".
 comes on.	Automatic Switch Off operates.	Deactivate the hob and activate it again.
 comes on.	The Child Safety Device function operates.	Refer to "Daily use".

Problem	Possible cause	Remedy
F comes on.	There is a fault.	To reset the fault, deactivate and activate the hob, after light animation, when F re-appears, touch and then ☰ within 3 seconds. When you see U the fault is reset. Make sure that the crown and the flame cap are correctly positioned, and clean the metal part of the flame safety device.
You can hear a constant beep noise.	The electrical connection is incorrect.	Disconnect the hob from the electrical supply. Ask a qualified electrician to check the installation.
E4 comes on.	The hob is too hot.	Wait a few minutes for cool down the hob. If possible, put the large cookware on the rear burners.
E6 comes on.	There is a fault.	Follow the same procedure as if F appeared.
E7 comes on.	Too many attempts to clear.	Wait for 15 minutes and follow the same procedure as if F appeared.
E and the number come on.	There is an error in the hob.	Disconnect the hob from the electrical supply for some time. Disconnect the fuse from the electrical system of the house. Connect it again. If E comes on again, speak to an Authorised Service Centre.
b comes on.	There is a dirt around burner area.	Refer to "Care and cleaning".

8.2 If you cannot find a solution...

If you cannot find a solution to the problem yourself, contact your dealer or an Authorised Service Centre. Give the data from the rating plate. Make sure, you operated the hob correctly. If not the

servicing by a service technician or dealer will not be free of charge, also during the warranty period. The instructions about the Service Centre and conditions of guarantee are in the guarantee booklet.

8.3 Labels supplied with the accessories bag

Stick the adhesive labels as indicated below:

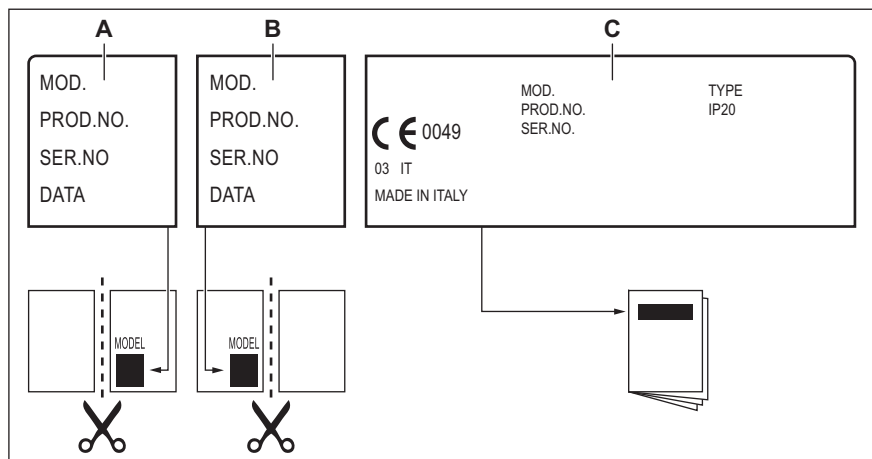

- A. Stick it on Guarantee Card and send this part (if applicable).
 B. Stick it on Guarantee Card and keep this part (if applicable).
 C. Stick it on instruction booklet.

9. TECHNICAL DATA

9.1 Hob dimensions

Width	750 mm
Depth	510 mm

9.2 Other technical data

TOTAL POWER:	Gas original:	G20 (2H) 20 mbar	10,2 kW
	Gas replacement:	G30 (3+) 28-30 mbar	749 g/h
		G31 (3+) 37 mbar	736 g/h
Electric supply:	220-240 V ~ 50-60 Hz		
Appliance category:	II2H3+		
Gas connection:	R 1/2"		

Appliance class:	3
------------------	---

9.3 Gas burners for NATURAL GAS G20 20 mbar

BURNER	NORMAL POWER kW	MINIMUM POWER kW	INJECTOR MARK
Multi Crown	3,5	1,75	146
Semi-rapid	1,9	0,7	96x
Auxiliary	1,0	0,38	76X

9.4 Gas burners for LPG G30/G31 28-30/37 mbar

BURNER	NORMAL POWER kW	MINIMUM POWER kW	INJECTOR MARK	NOMINAL GAS FLOW g/h	
				G30 28-30 mbar	G31 37 mbar
Multi Crown	3,6	1,8	095	262	257
Semi-rapid	1,9	0,75	71	138	136
Auxiliary	1,0	0,47	50	73	71

10. ENERGY EFFICIENCY

10.1 Product information according to EU 66/2014

Model identification	HVB75450IB	
Type of hob	Built-in hob	
Number of gas burners	5	
Energy efficiency per gas burner (EE gas burner)	Left rear - Semi-rapid	57.5%
	Right rear - Semi-rapid	57.5%
	Middle - Multi Crown	54.7%
	Left front - Semi-rapid	54.5%
	Right front - Auxiliary	not applicable
Energy efficiency for the gas hob (EE gas hob)	56.1%	

EN 30-2-1: Domestic cooking appliances burning gas - Part 2-1 : Rational use of energy - General

10.2 Energy saving

- Before use, make sure that the burners and pan supports are assembled correctly.

- Use cookware with diameters applicable to the size of burners.
- Center the pot on the burner.
- When you heat up water, use only the amount you need.
- If it is possible, always put the lids on the cookware.
- When the liquid starts to boil, turn down the flame to barely simmer the liquid.
- If it is possible, use a pressure cooker. Refer to its user manual.

11. ENVIRONMENTAL CONCERNS

Recycle materials with the symbol . Put the packaging in relevant containers to recycle it. Help protect the environment and human health by recycling waste of electrical and electronic appliances. Do not dispose of

appliances marked with the symbol  with the household waste. Return the product to your local recycling facility or contact your municipal office.

www.aeg.com/shop



867345684-D-362020



AEG