

USER MANUAL



CONTENTS

1. SAFETY INFORMATION.....	2
2. SAFETY INSTRUCTIONS.....	5
3. INSTALLATION.....	7
4. PRODUCT DESCRIPTION.....	8
5. QUICK GUIDE.....	9
6. BEFORE FIRST USE.....	11
7. DAILY USE.....	11
8. FLEXIBLE INDUCTION COOKING AREA.....	15
9. HINTS AND TIPS.....	18
10. CARE AND CLEANING.....	20
11. TROUBLESHOOTING.....	21
12. TECHNICAL DATA.....	24
13. ENERGY EFFICIENCY.....	25

FOR PERFECT RESULTS

Thank you for choosing this AEG product. We have created it to give you impeccable performance for many years, with innovative technologies that help make life simpler – features you might not find on ordinary appliances. Please spend a few minutes reading to get the very best from it.

Visit our website to:



Get usage advice, brochures, trouble shooter, service and repair information:
www.aeg.com/support



Register your product for better service:
www.registeraeg.com



Buy Accessories, Consumables and Original spare parts for your appliance:
www.aeg.com/shop

CUSTOMER CARE AND SERVICE

Always use original spare parts.

When contacting our Authorised Service Centre, ensure that you have the following data available: Model, PNC, Serial Number.

The information can be found on the rating plate.

 Warning / Caution-Safety information

 General information and tips

 Environmental information

Subject to change without notice.

1. SAFETY INFORMATION

Before the installation and use of the appliance, carefully read the supplied instructions. The manufacturer is not

responsible for any injuries or damages that are the result of incorrect installation or usage. Always keep the instructions in a safe and accessible location for future reference.

1.1 Children and vulnerable people safety

- This appliance can be used by children aged from 8 years and above and persons with reduced physical, sensory or mental capabilities or lack of experience and knowledge if they have been given supervision or instruction concerning the use of the appliance in a safe way and understand the hazards involved.
- Children between 3 and 8 years of age and persons with very extensive and complex disabilities shall be kept away from the appliance unless continuously supervised.
- Children of less than 3 years of age should be kept away from the appliance unless continuously supervised.
- Do not let children play with the appliance.
- Keep all packaging away from children and dispose of it appropriately.
- Keep children and pets away from the appliance when it operates or when it cools down. Accessible parts may become hot during use.
- If the appliance has a child safety device, it should be activated.
- Children shall not carry out cleaning and user maintenance of the appliance without supervision.

1.2 General Safety

- **WARNING:** The appliance and its accessible parts become hot during use. Care should be taken to avoid touching heating elements.
- **WARNING:** Unattended cooking on a hob with fat or oil can be dangerous and may result in fire.

- NEVER try to extinguish a fire with water, but switch off the appliance and then cover flame e.g. with a lid or a fire blanket.
- CAUTION: The appliance must not be supplied through an external switching device, such as a timer, or connected to a circuit that is regularly switched on and off by a utility.
- CAUTION: The cooking process has to be supervised. A short term cooking process has to be supervised continuously.
- WARNING: Danger of fire: Do not store items on the cooking surfaces.
- Metallic objects such as knives, forks, spoons and lids should not be placed on the hob surface since they can get hot.
- Do not use the appliance before installing it in the built-in structure.
- Do not use a steam cleaner to clean the appliance.
- After use, switch off the hob element by its control and do not rely on the pan detector.
- If the glass ceramic surface / glass surface is cracked, switch off the appliance and unplug it from the mains. In case the appliance is connected to the mains directly using junction box, remove the fuse to disconnect the appliance from power supply. In either case contact the Authorised Service Centre.
- If the supply cord is damaged, it must be replaced by the manufacturer, an authorized Service or similarly qualified persons in order to avoid a hazard.
- WARNING: Use only hob guards designed by the manufacturer of the cooking appliance or indicated by the manufacturer of the appliance in the instructions for use as suitable or hob guards incorporated in the appliance. The use of inappropriate guards can cause accidents.

2. SAFETY INSTRUCTIONS

2.1 Installation



WARNING!

Only a qualified person must install this appliance.



WARNING!

Risk of injury or damage to the appliance.

- Remove all the packaging.
- Do not install or use a damaged appliance.
- Follow the installation instructions supplied with the appliance.
- Keep the minimum distance from other appliances and units.
- Always take care when moving the appliance as it is heavy. Always use safety gloves and enclosed footwear.
- Seal the cut surfaces with a sealant to prevent moisture to cause swelling.
- Protect the bottom of the appliance from steam and moisture.
- Do not install the appliance adjacent to a door or under a window. This prevents hot cookware falling from the appliance when the door or the window is opened.
- Each appliance has cooling fans on the bottom.
- If the appliance is installed above a drawer:
 - Do not store any small pieces or sheets of paper that could be pulled in, as they can damage the cooling fans or impair the cooling system.
 - Keep a distance of minimum 2 cm between the bottom of the appliance and parts stored in the drawer.
- Remove any separator panels installed in the cabinet below the appliance.

- The appliance must be earthed.
- Before carrying out any operation make sure that the appliance is disconnected from the power supply.
- Make sure that the parameters on the rating plate are compatible with the electrical ratings of the mains power supply.
- Make sure the appliance is installed correctly. Loose and incorrect electricity mains cable or plug (if applicable) can make the terminal become too hot.
- Use the correct electricity mains cable.
- Do not let the electricity mains cable tangle.
- Make sure that a shock protection is installed.
- Use the strain relief clamp on the cable.
- Make sure the mains cable or plug (if applicable) does not touch the hot appliance or hot cookware, when you connect the appliance to the near sockets.
- Do not use multi-plug adapters and extension cables.
- Make sure not to cause damage to the mains plug (if applicable) or to the mains cable. Contact our Authorised Service Centre or an electrician to change a damaged mains cable.
- The shock protection of live and insulated parts must be fastened in such a way that it cannot be removed without tools.
- Connect the mains plug to the mains socket only at the end of the installation. Make sure that there is access to the mains plug after the installation.
- If the mains socket is loose, do not connect the mains plug.
- Do not pull the mains cable to disconnect the appliance. Always pull the mains plug.
- Use only correct isolation devices: line protecting cut-outs, fuses (screw type fuses removed from the holder), earth leakage trips and contactors.
- The electrical installation must have an isolation device which lets you

2.2 Electrical Connection



WARNING!

Risk of fire and electric shock.

- All electrical connections should be made by a qualified electrician.

disconnect the appliance from the mains at all poles. The isolation device must have a contact opening width of minimum 3 mm.

2.3 Use



WARNING!

Risk of injury, burns and electric shock.

- Remove all the packaging, labelling and protective film (if applicable) before first use.
- This appliance is for household use only.
- Do not change the specification of this appliance.
- Make sure that the ventilation openings are not blocked.
- Do not let the appliance stay unattended during operation.
- Set the cooking zone to "off" after each use.
- Do not rely on the pan detector.
- Do not put cutlery or saucepan lids on the cooking zones. They can become hot.
- Do not operate the appliance with wet hands or when it has contact with water.
- Do not use the appliance as a work surface or as a storage surface.
- If the surface of the appliance is cracked, disconnect immediately the appliance from the power supply. This to prevent an electrical shock.
- Users with a pacemaker must keep a distance of minimum 30 cm from the induction cooking zones when the appliance is in operation.
- When you place food into hot oil, it may splash.



WARNING!

Risk of fire and explosion

- Fats and oil when heated can release flammable vapours. Keep flames or heated objects away from fats and oils when you cook with them.
- The vapours that very hot oil releases can cause spontaneous combustion.
- Used oil, that can contain food remnants, can cause fire at a lower temperature than oil used for the first time.

- Do not put flammable products or items that are wet with flammable products in, near or on the appliance.



WARNING!

Risk of damage to the appliance.

- Do not keep hot cookware on the control panel.
- Do not put a hot pan cover on the glass surface of the hob.
- Do not let cookware boil dry.
- Be careful not to let objects or cookware fall on the appliance. The surface can be damaged.
- Do not activate the cooking zones with empty cookware or without cookware.
- Do not put aluminium foil on the appliance.
- Cookware made of cast iron, aluminium or with a damaged bottom can cause scratches on the glass / glass ceramic. Always lift these objects up when you have to move them on the cooking surface.
- This appliance is for cooking purposes only. It must not be used for other purposes, for example room heating.

2.4 Care and cleaning

- Clean the appliance regularly to prevent the deterioration of the surface material.
- Deactivate the appliance and let it cool down before you clean it.
- Disconnect the appliance from the electrical supply before maintenance.
- Do not use water spray and steam to clean the appliance.
- Clean the appliance with a moist soft cloth. Only use neutral detergents. Do not use any abrasive products, abrasive cleaning pads, solvents or metal objects.

2.5 Service

- To repair the appliance contact the Authorised Service Centre. Use original spare parts only.
- Concerning the lamp(s) inside this product and spare part lamps sold separately: These lamps are intended

to withstand extreme physical conditions in household appliances, such as temperature, vibration, humidity, or are intended to signal information about the operational status of the appliance. They are not intended to be used in other applications and are not suitable for household room illumination.

- Contact your municipal authority for information on how to discard the appliance correctly.
- Disconnect the appliance from the mains supply.
- Cut off the mains electrical cable close to the appliance and dispose of it.

2.6 Disposal



WARNING!
Risk of injury or suffocation.

3. INSTALLATION



WARNING!
Refer to Safety chapters.

3.1 Before the installation

Before you install the hob, write down the information below from the rating plate. The rating plate is on the bottom of the hob.

Serial number

3.2 Built-in hobs

Only use the built-in hobs after you assemble the hob into correct built-in units and work surfaces that align to the standards.

3.3 Connection cable

- For a single phase or two phase connection, use the cable type: H05BB-F or H03V2V2-F which withstands a temperature of 70 °C or higher.
- To replace the damaged mains cable, use the cable: H05BB-F or H03V2V2-F which withstands a temperature of 70 °C or higher.

3.4 Assembly

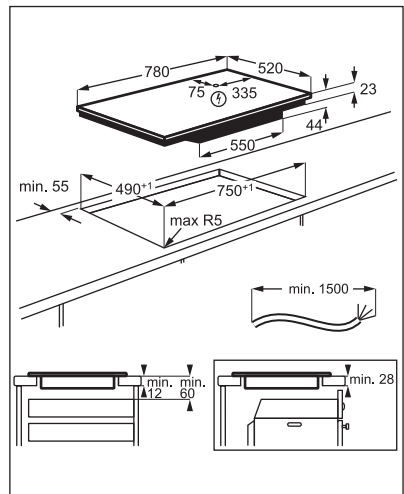
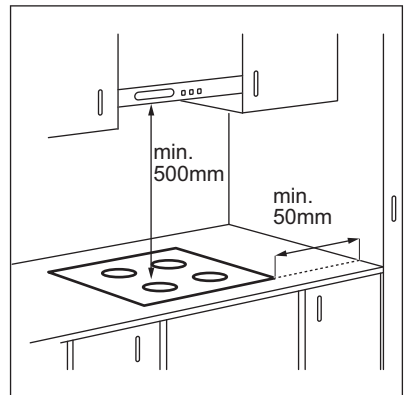



If the appliance is installed above a drawer, the hob ventilation can warm up the items stored in the drawer during the cooking process.

4. PRODUCT DESCRIPTION

4.1 Cooking surface layout

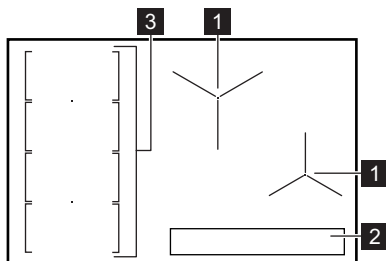

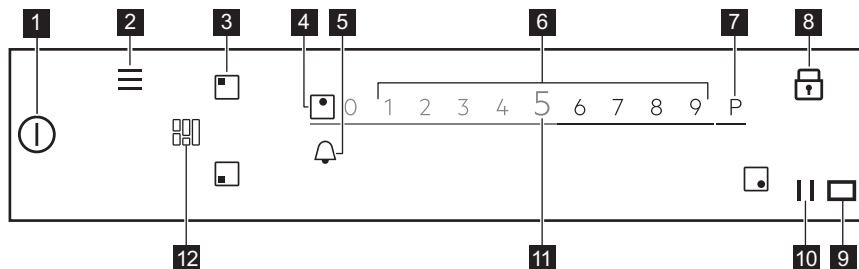

- 1** Induction cooking zone
- 2** Control panel
- 3** Flexible induction cooking area consisting of four sections

4.2 Control panel layout



To see the available settings touch the appropriate symbol.

Symbol	Comment
1	ON / OFF To activate and deactivate the hob.
2	Menu To open and close the Menu.
3	Zone selection To open the slider for the selected zone.
4 -	Zone indicator To show for which zone the slider is active.
5	- To set the timer functions.
6 -	Slider To adjust the heat setting.

Symbol	Comment
7 P	PowerBoost To activate the function.
8 	Lock To activate and deactivate the function.
9 	- The window of the Hob ² Hood infrared signal communicator. Do not cover it.
10	Pause To activate and deactivate the function.
11 0 - 9	- To show the current heat setting.
12 	FlexiBridge To switch between three modes of the function.

4.3 OptiHeat Control (3 step Residual heat indicator)



WARNING!

III / II / I There is a risk of burns from residual heat. The indicator shows the level of the residual heat.





The induction cooking zones produce the heat necessary for the cooking process directly in the bottom of the cookware. The glass ceramic is heated by the heat of the cookware.

5. QUICK GUIDE

5.1 Using the display

- Only the backlit symbols can be used.
- To activate a given option, touch the relevant symbol on the display.
- The selected function is activated when you remove the finger from the display.
- To scroll the available options, use a quick gesture or drag your finger across the display. The speed of the gesture determines how fast the screen moves.
- The scrolling can stop by itself or you can stop it immediately if you touch the display.
- You can change most of the parameters shown on the display when you touch the relevant symbols.
- To select the required function or time you can scroll through the list and / or touch the option you want to choose.
- When the hob is activated and some of the symbols disappear from the display, touch it again. All the symbols come back on.
- For certain functions, when you start them, a pop-up window with additional

- information appears. To deactivate the pop-up window permanently, check  before you activate the function.
- Select a zone first to activate the timer functions.

Symbols useful for display navigation	
OK	To confirm the selection or setting.
	To go back / forwards one level in the Menu.
	To scroll up / down the instructions on the display.
	To activate / deactivate the options.
	To close the pop-up window.
	To cancel a setting.

5.2 Menu structure

Touch  to access and change the settings of the hob or activate some

functions. The table shows the basic Menu structure.

Menu

Assisted Cooking		
Hob Functions	PowerSlide	
	Melting	
Settings	Child Lock	
	Stopwatch	
	Hob ² Hood	H0 - Off
		H1 - Light only
		H2 - Fan speed low
		H3 - Auto Fan Low
		H4 - Auto Fan Medium
		H5 - Auto Fan High
	Setup	H6 - Auto Fan Boost
		Assisted Cooking
		Language
		Key Tones
		Buzzer Volume
	Service	Display Brightness
		Demo Mode
License		
Show Software Version		
Alarm History		
	Reset All Settings	

To leave the Menu touch  or the right side of the display, outside of the pop-up window. To navigate through the Menu use < or >.

When you touch and hold some of the options available in the Menu, a short

description appears. Follow the tips to easily navigate through the Menu.

If you are at the bottom of the Menu scroll the list up and use < or touch  to leave the Menu.

6. BEFORE FIRST USE



WARNING!
Refer to Safety chapters.

6.1 First connection to the mains

When you connect the hob to the mains you have to set Language, Display Brightness and Buzzer Volume.

You can change the setting in Menu > Settings > Setup. Refer to "Daily use".

7. DAILY USE



WARNING!
Refer to Safety chapters.

7.1 Activating and deactivating

Touch  for 1 second to activate or deactivate the hob.

7.2 Automatic Switch Off

The function deactivates the hob automatically if:

- all cooking zones are deactivated,
- you do not set the heat setting after you activate the hob,
- you spill or put something on the control panel for more than 10 seconds (a pan, a cloth, etc.). An acoustic signal sounds and the hob deactivates. Remove the object or clean the control panel.
- the hob gets too hot (e.g. when a saucepan boils dry). Let the cooking zone cool down before you use the hob again.
- you use incorrect cookware or there is no cookware on a given zone. The white cooking zone symbol blinks and the induction cooking zone deactivates automatically after 1 minute.
- you do not deactivate a cooking zone or change the heat setting. After some time a message comes on and the hob deactivates.

The relation between the heat setting and the time after which the hob deactivates:

Heat setting	The hob deactivates after
1 - 2	6 hours
3 - 5	5 hours
6	4 hours
7 - 9	1.5 hour

7.3 Heat setting

1. Activate the hob.
2. Place the pot on the selected cooking zone.

The slider for the active cooking zone appears on the display and is active for 8 seconds.

3. Touch or slide your finger to set the desired heat setting.

The symbol turns red and becomes bigger.

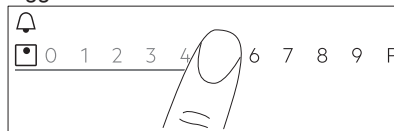

7.4 Using the cooking zones

Place the cookware in the centre of the selected cooking zone. Induction cooking zones adapt to the dimensions of the bottom of the cookware automatically.

Once you place a pot on the selected cooking zone the hob automatically detects it and the relevant slider appears on the display. The slider is visible for 8

seconds, after that time the display goes back to the main view. To close the slider faster tap the screen outside of the slider area.

When other zones are active the heat setting for the zone you want to use may be limited. Refer to "Power Management".



Make sure that the pot is suitable for induction hobs. For more information on cookware types refer to "Hints and tips". Check the size of the pot in "Technical data".

7.5 PowerBoost

This function activates more power for the appropriate induction cooking zone; it depends on the cookware size. The function can be activated only for a limited period of time.

1. Touch the desired zone symbol first.
2. Touch **P** or slide your finger to the right to activate the function for the chosen cooking zone.

The symbol turns red and becomes bigger.

The function deactivates automatically. To deactivate the function manually select the zone and change its heat setting.



For maximum duration values, refer to "Technical data".

7.6 Power Management

- Cooking zones are grouped according to the location and number of the phases in the hob. See the illustration.
- Each phase has a maximum electricity loading of 3680 W.
- The function divides the power between cooking zones connected to the same phase.
- The function activates when the total electricity loading of the cooking zones connected to a single phase exceeds 3680 W.
- The function decreases the power of the other cooking zones connected to the same phase, which has an

influence on the available heat setting.

- The maximum heat setting is visible on the slider. Only the digits in white are active.
- If a higher heat setting is not available reduce it for the other cooking zones first.

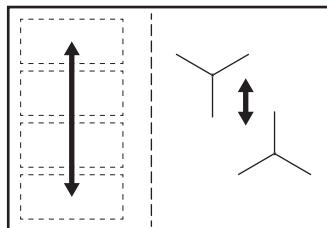

7.7 Timer



Count Down Timer

Use this function to specify how long a cooking zone should operate during a single cooking session.

You can set the function for each cooking zone separately.

1. Set the heat setting for the appropriate cooking zone first and then set the function.
2. Touch the zone symbol.

3. Touch

The timer menu window appears on the display.

4. Check to activate the function.

The symbols change to .

5. Slide your finger to the left or right to select the desired time (e.g. hours and/or minutes).
6. Touch OK to confirm your selection.

You can also choose **X** to cancel your selection.

When the time comes to an end, a signal sounds and blinks. Touch to stop the signal.

To deactivate the function set the heat setting to **0**. Alternatively, touch to the left of the timer value, touch **X** next to it and confirm your choice when a pop-up window appears.

Minute Minder

You can use this function when the hob is activated but the cooking zones do not operate.

The function has no effect on the operation of the cooking zones.

1. Select any cooking zone. The relevant slider appears on the display.



2. Touch .



The timer menu window appears on the display.

3. Slide your finger to the left or right to select the desired time (e.g. hours and minutes).

4. Touch OK to confirm your selection.

You can also choose  to cancel your selection.



When the time comes to an end, a signal sounds and  blinks. Touch  to stop the signal.

To deactivate the function touch  to the left of the timer value, touch  next to it and confirm your choice when a pop-up window appears.

Stopwatch



The function automatically starts counting immediately after you activate a cooking zone. You can use this function to monitor how long it operates.

1. Touch  to access the Menu.
2. Scroll the Menu to select Settings > Stopwatch.
3. Touch the switch to turn the function on / off.

The function does not stop when you lift the pot. To reset the function and start it again manually touch , select Reset from the pop-up window. The function starts counting from 0. To Pause the function for one cooking session touch  and select Pause from the pop-up window. Select Start to continue counting.

7.8 Pause

This function sets all cooking zones that operate to the lowest heat setting.

When the function operates only  and  symbols can be used. All other symbols on the control panel are locked.

The function does not stop the timer functions.

Touch  to activate the function.

 comes on. The heat setting is lowered to 1.

To deactivate the function touch .

The function stops PowerBoost. The highest heat setting reactivates when you touch  again.

7.9 Lock

You can lock the control panel while the hob operates. It prevents an accidental change of the heat setting.

Set the heat setting first.

Touch  to activate the function.

To deactivate the function, touch  for 3 seconds.





When you deactivate the hob, you also deactivate this function.

7.10 Child Lock

This function prevents an accidental operation of the hob.

1. Touch  on the display to open the Menu.
2. Select Settings > Child Lock from the list.
3. Turn the switch on and touch the letters A-O-X in the alphabetical order to activate the function. To deactivate the function turn the switch off.

To leave the Menu, touch  or the right side of the display, outside of the pop-up window. To navigate through the Menu, use  or .

7.11 Language

1. Touch  on the display to open the Menu.
2. Select Settings > Setup > Language from the list.
3. Choose the appropriate language from the list.

If you chose the wrong language, touch . A list appears. Select the third option once and then the last option twice. Finally, choose the option on the right.

To leave the Menu, touch  or the right side of the display, outside of the pop-up window. To navigate through the Menu, use < or >.

7.12 Key Tones / Buzzer Volume

You can choose the type of sound your hob emits or turn the sounds off entirely. You can choose between the click (default) or beep.

1. Touch  on the display to open the Menu.
2. Select Settings > Setup > Key Tones / Buzzer Volume from the list.
3. Choose the appropriate option.

To leave the Menu, touch  or the right side of the display, outside of the pop-up window. To navigate through the Menu, use < or >.

7.13 Display Brightness

You can change the brightness of the display.

There are 4 brightness levels, 1 is the lowest and 4 is the highest.



1. Touch  on the display to open the Menu.
2. Select Settings > Setup > Display Brightness from the list.
3. Choose the appropriate level.

To leave the Menu, touch  or the right side of the display, outside of the pop-up window. To navigate through the Menu, use < or >.

7.14 Assisted Cooking

This function adjusts the temperature to different types of food and maintains it throughout cooking. It can only be activated for the left front cooking zone or both zones on the left when bridged.

1. Touch  on the display to open the Menu.
2. Select Assisted Cooking and choose the type of food you would like to prepare from the list.
For each type of food there are a few options available. Follow the instructions shown on the display.
 - You can touch OK on top of the pop-up window to use the default settings.
 - You can set the timer function. When the pot reaches the intended temperature you can activate the timer.
 - You can change the default heat level.
3. Once the pot reaches the intended temperature an acoustic signal sounds and a pop-up window appears. To close the window and start the function touch OK. To deactivate the window permanently check before you activate the function.

To stop the function touch  and Stop or touch  and select Assisted Cooking, choose any type of food and touch Stop.



To leave the Menu touch  or the right side of the display, outside of the pop-up window. To navigate through the Menu use < or >.

7.15 Melting

You can use this function to melt different products, e.g. chocolate or butter. You can use the function only for one cooking zone at a time.

1. Touch  on the display to open the Menu.
2. Select Hob Functions > Melting from the list.
3. Touch Start

You need to select the desired zone. A pop-up window appears, asking if you want to cancel the previous heat setting if there was any.

To leave the Menu, touch  or the right side of the display, outside of the pop-up window. To navigate through the Menu, use  or .

To stop the function, touch the zone selection symbol and then touch Stop.

7.16 Hob²Hood

It is an advanced automatic function which connects the hob to a special hood. Both the hob and the hood have an infrared signal communicator. The speed of the fan is defined automatically on the basis of the mode setting and the temperature of the hottest pot on the hob.

For most of the hoods the remote system is originally deactivated. Activate it before you use the function. For more information refer to the hood user manual.

To operate the function automatically, set the automatic mode to H1 - H6. The hob is originally set to H5. The hood reacts whenever you operate the hob. The hob recognizes the temperature of the cookware automatically and adjusts the speed of the fan. You can set the hob to activate only the light by selecting H1.

 If you change the fan speed on the hood, the default connection with the hob is deactivated. To reactivate the function, turn both appliances OFF and ON again.

Mode	Automatic light	Boiling ¹⁾	Frying ²⁾
H0	Off	Off	Off

Mode	Automatic light	Boiling ¹⁾	Frying ²⁾
H1	On	Off	Off
H2 ³⁾	On	Fan speed 1	Fan speed 1
H3	On	Off	Fan speed 1
H4	On	Fan speed 1	Fan speed 1
H5	On	Fan speed 1	Fan speed 2
H6	On	Fan speed 2	Fan speed 3

1) The hob detects the boiling process and activates fan speed in accordance with the automatic mode.

2) The hob detects the frying process and activates fan speed in accordance with the automatic mode.

3) This mode activates the fan and the light and does not rely on the temperature.

Changing the modes

If you are not satisfied with the noise level / fan speed, you can switch between modes manually.

1. Touch .
Select Settings > Hob²Hood from the list.
2. Choose the appropriate mode.

To leave the Menu touch  or the right side of the display, outside of the pop-up window.

When you finish cooking and deactivate the hob, the hood fan may still operate for a certain period of time. After that time the system deactivates the fan automatically and prevents you from an accidental activation for the next 30 seconds.

The light on the hood deactivates 2 minutes after deactivating the hob.

8. FLEXIBLE INDUCTION COOKING AREA



WARNING!
Refer to Safety chapters.

8.1 FlexiBridge

The area on the left side can be combined into two cooking zones with different sizes, or into one large cooking area. You may choose a combination of 4 sections which depends on the size of the cookware you want to use. The cooking zone indicators change automatically and show the possible combination.

FlexiBridge Standard is the default mode which activates automatically when you activate the hob. Two cooking zones operate independently.

Touch  to switch between the FlexiBridge modes.

8.2 FlexiBridge Standard mode

This mode is active when you activate the hob. It connects the sections into two separate cooking zones. You can set the heat setting for each zone separately.

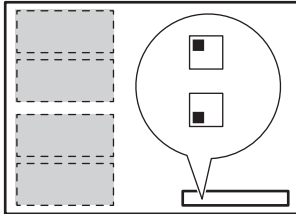

Correct cookware position:

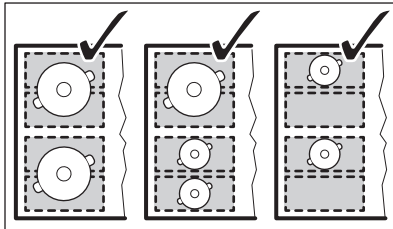

Incorrect cookware position:

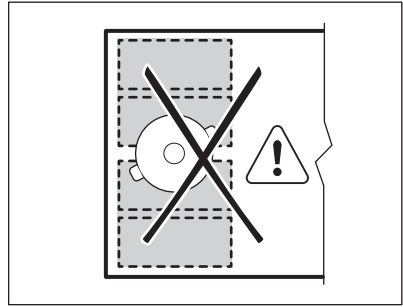

8.3 FlexiBridge Big Bridge mode

To activate the mode touch  until you see the correct mode indicator. This mode connects three rear sections into one cooking zone. The front section is not connected and operates as a separate cooking zone. You can set the heat setting for each zone separately.

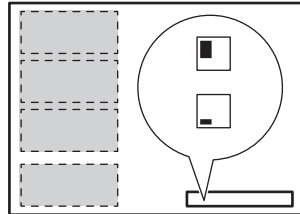

Correct cookware position:

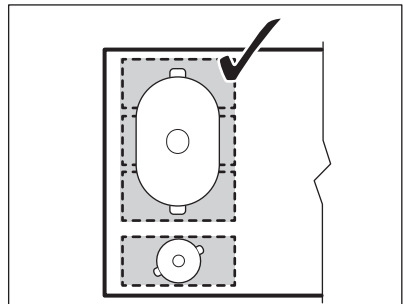

To use this mode you have to place the cookware on the three connected sections. If you use cookware smaller than two sections the  blinks on the display and after 1 minute the zone switches off.

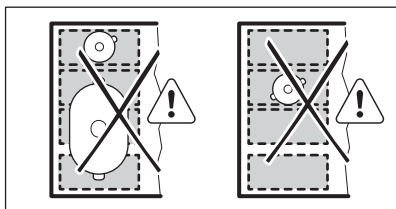

Incorrect cookware position:



8.4 FlexiBridge Max Bridge mode

To activate the mode touch  until you see the correct mode indicator . This mode connects all sections into one cooking zone.

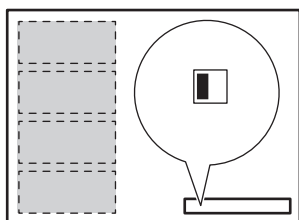

Correct cookware position:

To use this mode you have to place the cookware on the four connected sections. If you use cookware smaller than three sections the display shows  and after 1 minute the zone switches off.

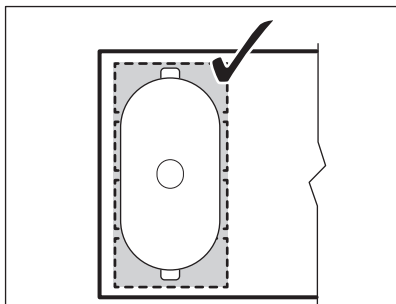

Incorrect cookware position:

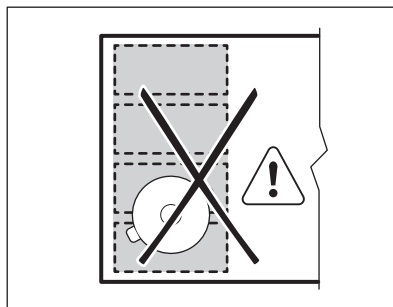



8.5 PowerSlide

This function allows you to adjust the temperature by moving the cookware to a different position on the induction cooking surface. This function automatically divides the left cooking zones into three areas with different heat settings. The hob detects the position of the cookware and adjusts the pre-set power level accordingly. You can place the pot in the front, middle or rear position. If you place the cookware at the front you get the highest heat setting (i.e. 9). To decrease it, move the cookware to the middle (heat setting - 5) or rear position (heat setting -1).



Use only one pot with a minimum bottom diameter of 160 mm when you operate the function.

1. Touch  once.
2. Scroll the Menu > Hob Functions to select the function from the list.
 - If any of the left zones operates a pop-up window appears asking you to confirm whether or not you want to cancel the previous heat settings.
 - The  symbol and the symbols of three zones with default heat settings appear on the display. You can change the default heat setting in accordance with your needs and the heat setting will be saved for future use.
3. Place the pot on the cooking zone with the desired heat setting. Place the cookware in the centre of the desired zone and make sure you do not cover the neighbouring zones.

Red indicators come on. Unless you see the red indicators the function cannot be activated.

If you want to change the position of the pot lift it up and place on a different zone. Sliding the cookware can cause scratches and discolouration of the surface.

To deactivate the function touch , a pop-up window appears. Touch Stop to

deactivate the function. You can also deactivate the function from the Menu.

-  Move the pot from time to time. The function deactivates after 10 minutes of inactivity.

9. HINTS AND TIPS



WARNING!
Refer to Safety chapters.

9.1 Cookware



For induction cooking zones a strong electro-magnetic field creates the heat in the cookware very quickly.



Use the induction cooking zones with suitable cookware.

Cookware material

- **correct:** cast iron, steel, enamelled steel, stainless steel, multi-layer bottom (with a correct marking from a manufacturer).
- **not correct:** aluminium, copper, brass, glass, ceramic, porcelain.

Cookware is suitable for an induction hob if:

- water boils very quickly on a zone set to the highest heat setting.
- a magnet pulls on to the bottom of the cookware.



The bottom of the cookware must be as thick and flat as possible. Ensure pan bases are clean and dry before placing on the hob surface.

Cookware dimensions

Induction cooking zones adapt to the dimension of the bottom of the cookware automatically.

The cooking zone efficiency is related to the diameter of the cookware. The cookware with a diameter smaller than the minimum receives only a part of the power generated by the cooking zone.



Refer to "Technical data".

9.2 Correct pans for Pan Fry function

Use only pans with flat bottom. To check if the pan is correct:

1. Put your pan upside down.
2. Put a ruler on the bottom of the pan.
3. Try to put a coin of 1, 2 or 5 Euro Cent (or with similar thickness) between the ruler and the bottom of the pan.

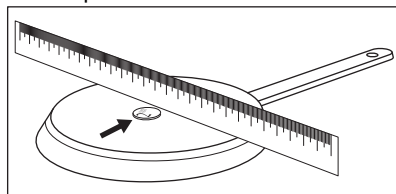

- a. The pan is incorrect if you can put the coin between the ruler and the pan.

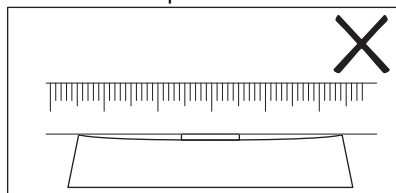

- b. The pan is correct if you cannot put the coin between the ruler and the pan.

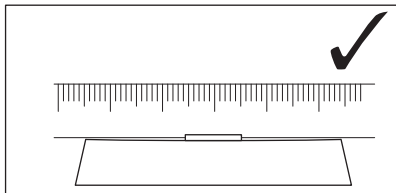

9.3 The noises during operation

If you can hear:

- crack noise: cookware is made of different materials (a sandwich construction).
- whistle sound: you use a cooking zone with a high power level and the cookware is made of different materials (a sandwich construction).
- humming: you use a high power level.
- clicking: electric switching occurs, the pot is detected after you place it on the hob.
- hissing, buzzing: the fan operates.

The noises are normal and do not indicate any malfunction.

9.4 Öko Timer (Eco Timer)

To save energy, the heater of the cooking zone deactivates before the count down timer sounds. The difference in the operation time depends on the heat setting level and the length of the cooking operation.

9.5 Examples of cooking applications

The correlation between the heat setting of a zone and its consumption of power is not linear. When you increase the heat setting, it is not proportional to the increase of the consumption of power. It means that a cooking zone with the medium heat setting uses less than a half of its power.



The data in the table is for guidance only.

Heat setting	Use to:	Time (min)	Hints
1	Keep cooked food warm.	as necessary	Put a lid on the cookware.
1 - 2	Hollandaise sauce, melt: butter, chocolate, gelatine.	5 - 25	Mix from time to time.
1 - 2	Solidify: fluffy omelettes, baked eggs.	10 - 40	Cook with a lid on.
2 - 3	Simmer rice and milkbased dishes, heat up ready-cooked meals.	25 - 50	Add at least twice as much liquid as rice, mix milk dishes halfway through the procedure.
3 - 4	Steam vegetables, fish, meat.	20 - 45	Add a couple of tablespoons of liquid.
4 - 5	Steam potatoes.	20 - 60	Use max. ¼ l of water for 750 g of potatoes.
4 - 5	Cook larger quantities of food, stews and soups.	60 - 150	Up to 3 l of liquid plus ingredients.

Heat setting	Use to:	Time (min)	Hints
6 - 7	Gentle fry: escalope, veal cordon bleu, cutlets, rissoles, sausages, liver, roux, eggs, pancakes, doughnuts.	as necessary	Turn halfway through.
7 - 8	Heavy fry, hash browns, loin steaks, steaks.	5 - 15	Turn halfway through.
9	Boil water, cook pasta, sear meat (goulash, pot roast), deep-fry chips.		
P	Boil large quantities of water. PowerBoost is activated.		

9.6 Hints and Tips for Hob²Hood

When you operate the hob with the function:

- Protect the hood panel from direct sunlight.
- Do not spot halogen light on the hood panel.
- Do not cover the hob control panel.
- Do not interrupt the signal between the hob and the hood (e.g. with the hand, a cookware handle or a tall pot). See the picture.

The hood in the picture is only exemplary.

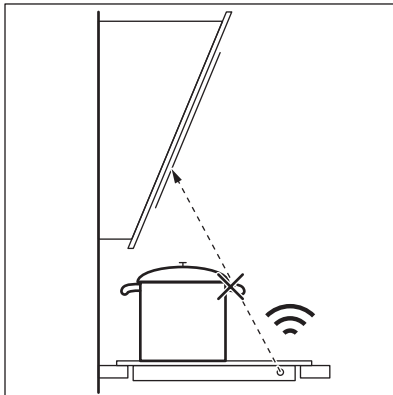

i Keep the window of the Hob²Hood infrared signal communicator clean.

i Other remotely controlled appliances may block the signal. Do not use any such appliances near to the hob while Hob²Hood is on.

Cooker hoods with the Hob²Hood function

To find the full range of cooker hoods which work with this function refer to our consumer website. The AEG cooker hoods that work with this function must have the symbol .

10. CARE AND CLEANING



WARNING!
Refer to Safety chapters.

10.1 General information

- Clean the hob after each use.

- Always use cookware with a clean base.
- Scratches or dark stains on the surface have no effect on how the hob operates.
- Use a special cleaner suitable for the surface of the hob.
- Use a special scraper for the glass.



The printing on the flexible induction cooking area may become dirty or change its colour from sliding the cookware. You can clean the area in a standard way.

10.2 Cleaning the hob

- **Remove immediately:** melted plastic, plastic foil, sugar and food with sugar, otherwise, the dirt can cause damage to the hob. Take care to avoid burns.

- Use a special hob scraper on the glass surface at an acute angle and move the blade on the surface.
- **Remove when the hob is sufficiently cool:** limescale rings, water rings, fat stains, shiny metallic discoloration. Clean the hob with a moist cloth and a non-abrasive detergent. After cleaning, wipe the hob dry with a soft cloth.
- **Remove shiny metallic discoloration:** use a solution of water with vinegar and clean the glass surface with a cloth.
- The surface of the hob has horizontal grooves. Clean the hob with a moist cloth and some detergent with smooth movement from left to right. After cleaning, wipe the hob dry with a soft cloth from left to right.

11. TROUBLESHOOTING





WARNING!



Refer to Safety chapters.

11.1 What to do if...

Problem	Possible cause	Remedy
You cannot activate or operate the hob.	The hob is not connected to an electrical supply or it is connected incorrectly.	Check if the hob is correctly connected to the electrical supply. Refer to the connection diagram.
	The fuse is blown.	Make sure that the fuse is the cause of the malfunction. If the fuse is blown again and again, contact a qualified electrician.
	You do not set the heat setting for 60 seconds.	Activate the hob again and set the heat setting in less than 60 seconds.
	You touched 2 or more sensor fields at the same time.	Touch only one sensor field.
	Pause operates.	Refer to "Daily use".

Problem	Possible cause	Remedy
The display does not react to the touch.	Part of the display is covered or the pots are placed too near to the display. There is some liquid or an object on the display.	Remove the objects. Move the pots away from the display. Clean the display, wait until the appliance is cold. Disconnect the hob from the electrical supply. After 1 min, connect the hob again.
An acoustic signal sounds and the hob deactivates. An acoustic signal sounds when the hob is deactivated.	You put something on one or more sensor fields.	Remove the object from the sensor fields.
The hob deactivates.	You put something on the sensor field ①.	Remove the object from the sensor field.
Residual heat indicator does not come on.	The zone is not hot because it operated only for a short time or the sensor under the hob surface is damaged.	If the zone operated sufficiently long to be hot, speak to an Authorised Service Centre.
You cannot activate the highest heat setting.	Another zone is already set to the highest heat setting.	First reduce the power of the other zone.
The sensor fields become hot.	The cookware is too large or you put it too near to the controls.	Put large cookware on the rear zones if possible.
Hob ² Hood does not work.	You covered the control panel.	Remove the object from the control panel.
Hob ² Hood operates, but only the light is on.	You activated the H1 mode.	Change the mode to H2 - H6 or wait until the automatic mode starts.
Hob ² Hood modes H1 - H6 operate, but the light is off.	There might be a problem with the light bulb.	Contact an Authorised Service Centre.
There is no sound when you touch the panel sensor fields.	The sounds are deactivated.	Activate the sounds. Refer to "Daily use".
Wrong language is set.	You changed the language by mistake.	Reset all functions to the factory settings. Select Reset All Settings from the Menu. Disconnect the hob from the electrical supply. After 1 min, connect the hob again. Set Language, Display Brightness and Buzzer Volume.

Problem	Possible cause	Remedy
The flexible induction cooking area does not heat up the cookware.	The cookware is in a wrong position on the flexible induction cooking area.	Place the cookware in the correct position on the flexible induction cooking area. The position of the cookware depends on the activated function or function mode. Refer to "Flexible induction cooking area".
	The diameter of the bottom of the cookware is incorrect for the activated function or function mode.	Use cookware with a diameter applicable to the activated function or function mode. Use cookware with a diameter smaller than 160 mm on a single section of the flexible induction cooking area. Refer to "Flexible induction cooking area".
A cooking zone deactivates. A warning message saying the cooking zone is going to switch off comes on.	Automatic Switch Off deactivates the cooking zone.	Refer to "Daily use". Deactivate the hob and activate it again.
 and a message come on.	Lock operates.	Refer to "Daily use".
O - X - A appears.	Child Lock operates.	Refer to "Daily use".
 blinks.	There is no cookware on the zone.	Put cookware on the zone.
	The cookware is unsuitable.	Use suitable cookware. Refer to "Hints and tips".
	The diameter of the bottom of the cookware is too small for the zone.	Use cookware with correct dimensions. Refer to "Technical data".
	FlexiBridge operates. One or more sections of the function mode which operates are not covered by the cookware.	Place the cookware on the correct number of sections of the function mode which operates or change the function mode. Refer to "Flexible induction cooking area".
	PowerSlide operates. Two pots are placed on the flexible induction cooking area.	Use only one pot. Refer to "Flexible induction cooking area".

Problem	Possible cause	Remedy
 and a number come on.	There is an error in the hob.	Deactivate the hob and activate it again after 30 seconds. If  comes on again, disconnect the hob from the electrical supply. After 30 seconds, connect the hob again. If the problem continues, speak to an Authorised Service Centre.
You can hear a constant beep noise.	The electrical connection is incorrect.	Disconnect the hob from the electrical supply. Ask a qualified electrician to check the installation.

11.2 If you cannot find a solution...

If you cannot find a solution to the problem yourself, contact your dealer or an Authorised Service Centre. Give the data from the rating plate. Make sure, you operated the hob correctly. If not the

servicing by a service technician or dealer will not be free of charge, also during the warranty period. The instructions about the Service Centre and conditions of guarantee are in the guarantee booklet.

12. TECHNICAL DATA

12.1 Rating plate

Model IAE84851FB
Typ 62 D4A 05 CA
Induction 7.35 kW
Ser.Nr.
AEG

PNC 949 597 566 00
220 - 240 V / 400 V 2N 50 - 60 Hz
Made in Germany
7.35 kW

12.2 Software Licences

The software included in the hob contains copyrighted software that is licensed under the BSD, fontconfig, FTL, GPL-2.0, LGPL-2.0, LGPL-2.1, libJpeg, zLib/ libpng, MIT, OpenSSL / SSLEAY ISC, Apache 2.0 and others.

Check the full copy of the licence in: Menu > Settings > Service > License.

You can download the source code of the open source software by following the hyperlink present in the web product page.

12.3 Cooking zones specification

Cooking zone	Nominal power (maximum heat setting) [W]	PowerBoost [W]	PowerBoost maximum duration [min]	Cookware diameter [mm]
Middle rear	2300	3200	10	125 - 210
Right front	1800	2800	10	145 - 180
Flexible induction cooking area	2300	3200	10	minimum 100

The power of the cooking zones can be different in some small range from the data in the table. It changes with the material and dimensions of the cookware.

For optimal cooking results use cookware no larger than the diameter in the table.

13. ENERGY EFFICIENCY

13.1 Product information according to EU 66/2014 valid for EU market only

Model identification	IAE84851FB		
Type of hob	Built-In Hob		
Number of cooking zones	2		
Number of cooking areas	1		
Heating technology	Induction		
Diameter of circular cooking zones (Ø)	Middle rear Right front	21.0 cm 18.0 cm	
Length (L) and width (W) of the cooking area	Left	L 45.6 cm W 21.6 cm	
Energy consumption per cooking zone (EC electric cooking)	Middle rear Right front	189.1 Wh / kg 178.3 Wh / kg	
Energy consumption of the cooking area (EC electric cooking)	Left	187.0 Wh / kg	
Energy consumption of the hob (EC electric hob)	185.7 Wh / kg		

EN 60350-2 - Household electric cooking appliances - Part 2: Hobs - Methods for measuring performance

13.2 Energy saving

You can save energy during everyday cooking if you follow below hints.

- When you heat up water, use only the amount you need.
- If it is possible, always put the lids on the cookware.
- Before you activate the cooking zone put the cookware on it.
- Put the smaller cookware on the smaller cooking zones.
- Put the cookware directly in the centre of the cooking zone.
- Use the residual heat to keep the food warm or to melt it.

14. ENVIRONMENTAL CONCERNS

Recycle materials with the symbol . Put the packaging in relevant containers to recycle it. Help protect the environment and human health by recycling waste of electrical and electronic appliances. Do not dispose of

appliances marked with the symbol  with the household waste. Return the product to your local recycling facility or contact your municipal office.

www.aeg.com/shop



867350557-C-102021



AEG