

USER MANUAL



CONTENTS

1. SAFETY INFORMATION.....	3
2. CONDITIONS OF USE.....	5
3. SAFETY INSTRUCTIONS.....	5
4. INSTALLATION.....	7
5. PRODUCT DESCRIPTION.....	8
6. BEFORE FIRST USE.....	11
7. DAILY USE.....	13
8. HINTS AND TIPS.....	20
9. CARE AND CLEANING.....	27
10. TROUBLESHOOTING.....	28
11. TECHNICAL DATA.....	32
12. ENERGY EFFICIENCY.....	33
13. WARRANTY	33
14. ENVIRONMENTAL CONCERNS.....	36

IMPORTANT INFORMATION THAT MAY IMPACT YOUR MANUFACTURER'S WARRANTY

Adherence to the directions for use in this manual is extremely important for health and safety. Failure to strictly adhere to the requirements in this manual may result in personal injury, property damage and affect your ability to make a claim under the AEG manufacturer's warranty provided with your product. Products must be used, installed and operated in accordance with this manual. You may not be able to claim on the AEG manufacturer's warranty in the event that your product fault is due to failure to adhere to this manual.

FOR PERFECT RESULTS

Thank you for choosing this AEG product. We have created it to give you impeccable performance for many years, with innovative technologies that help make life simpler features you might not find on ordinary appliances. Please spend a few minutes reading to get the very best from it. Visit our website for:



Get usage advice, brochures, trouble shooter, service information:
www.aeg.com



Register your product for better service:
www.registeraeg.com



Buy Accessories, Consumables and Original spare parts for your appliance:
www.aeg.com/shop

CUSTOMER CARE AND SERVICE

Always use original spare parts.

When contacting our Authorised Service Centre, ensure that you have the following data available: Model, PNC, Serial Number.

The information can be found on the rating plate.

 Warning / Caution-Safety information

 General information and tips

 Environmental information

Subject to change without notice.

1. SAFETY INFORMATION

Before the installation and use of the appliance, carefully read the supplied instructions. The manufacturer is not responsible for any injuries or damage that are the result of incorrect installation or usage. Always keep the instructions in a safe and accessible location for future reference.

1.1 Children and vulnerable people safety

- This appliance can be used by children aged from 8 years and above and persons with reduced physical, sensory or mental capabilities or lack of experience and knowledge if they have been given supervision or instruction concerning the use of the appliance in a safe way and understand the hazards involved.
- Children between 3 and 8 years of age and persons with very extensive and complex disabilities shall be kept away from the appliance unless continuously supervised.
- Children of less than 3 years of age should be kept away from the appliance unless continuously supervised.
- Do not let children play with the appliance.
- Keep all packaging away from children and dispose of it appropriately.
- Keep children and pets away from the appliance when it operates or when it cools down. Accessible parts may become hot during use.
- If the appliance has a child safety device, it should be activated.
- Children shall not carry out cleaning and user maintenance of the appliance without supervision.

1.2 General Safety

- **WARNING:** The appliance and its accessible parts become hot during use. Care should be taken to avoid touching heating elements.
- **WARNING:** Unattended cooking on a hob with fat or oil can be dangerous and may result in fire.
- **NEVER** try to extinguish a fire with water, but switch off the appliance and then cover flame e.g. with a lid or a fire blanket.
- **CAUTION:** The appliance must not be supplied through an external switching device, such as a timer, or connected to a circuit that is regularly switched on and off by a utility.
- **CAUTION:** The cooking process has to be supervised. A short term cooking process has to be supervised continuously.
- **WARNING:** Danger of fire: Do not store items on the cooking surfaces.
- Metallic objects such as knives, forks, spoons and lids should not be placed on the hob surface since they can get hot.
- Do not use the appliance before installing it in the built-in structure.
- Do not use a steam cleaner to clean the appliance.
- After use, switch off the hob element by its control and do not rely on the pan detector.
- If the glass ceramic surface / glass surface is cracked, switch off the appliance and unplug it from the mains. In case the appliance is connected to the mains directly using junction box, remove the fuse to disconnect the appliance from power supply. In either case contact the Authorised Service Centre.
- If the supply cord is damaged, it must be replaced by the manufacturer, an authorized Service or similarly qualified persons in order to avoid a hazard.
- **WARNING:** Use only hob guards designed by the manufacturer of the cooking appliance or indicated by

the manufacturer of the appliance in the instructions for use as suitable or hob guards incorporated in the appliance. The use of inappropriate guards can cause accidents.

2. CONDITIONS OF USE

This appliance is intended to be used in household and similar applications such as:

- Farm houses

- By clients in serviced apartments, holiday apartments and other residential type environments.

3. SAFETY INSTRUCTIONS

3.1 Installation



WARNING!

Only a qualified person must install this appliance.



WARNING!

Risk of injury or damage to the appliance.

- Remove all the packaging.
- Do not install or use a damaged appliance.
- Follow the installation instructions supplied with the appliance.
- Keep the minimum distance from other appliances and units.
- Always take care when moving the appliance as it is heavy. Always use safety gloves and enclosed footwear.
- Seal the cut surfaces with a sealant to prevent moisture to cause swelling.
- Protect the bottom of the appliance from steam and moisture.
- Do not install the appliance adjacent to a door or under a window. This prevents hot cookware falling from the appliance when the door or the window is opened.
- Each appliance has cooling fans on the bottom.
- If the appliance is installed above a drawer:
 - Do not store any small pieces or sheets of paper that could be pulled in, as they can damage the cooling fans or impair the cooling system.

- Keep a distance of minimum 2 cm between the bottom of the appliance and parts stored in the drawer.

- Remove any separator panels installed in the cabinet below the appliance.

3.2 Electrical Connection



WARNING!

Risk of fire and electric shock.

- All electrical connections should be made by a qualified electrician.
- The appliance must be earthed.
- Before carrying out any operation make sure that the appliance is disconnected from the power supply.
- Make sure that the parameters on the rating plate are compatible with the electrical ratings of the mains power supply.
- Make sure the appliance is installed correctly. Loose and incorrect electricity mains cable or plug (if applicable) can make the terminal become too hot.
- Use the correct electricity mains cable.
- Do not let the electricity mains cable tangle.
- Make sure that a shock protection is installed.
- Use the strain relief clamp on the cable.
- Make sure the mains cable or plug (if applicable) does not touch the hot

appliance or hot cookware, when you connect the appliance to the near sockets.

- Do not use multi-plug adapters and extension cables.
 - Make sure not to cause damage to the mains plug (if applicable) or to the mains cable. Contact our Authorised Service Centre or an electrician to change a damaged mains cable.
 - The shock protection of live and insulated parts must be fastened in such a way that it cannot be removed without tools.
 - Connect the mains plug to the mains socket only at the end of the installation. Make sure that there is access to the mains plug after the installation.
 - If the mains socket is loose, do not connect the mains plug.
 - Do not pull the mains cable to disconnect the appliance. Always pull the mains plug.
 - Use only correct isolation devices: line protecting cut-outs, fuses (screw type fuses removed from the holder), earth leakage trips and contactors.
 - The electrical installation must have an isolation device which lets you disconnect the appliance from the mains at all poles. The isolation device must have a contact opening width of minimum 3 mm.
- Do not put cutlery or saucepan lids on the cooking zones. They can become hot.
 - Do not operate the appliance with wet hands or when it has contact with water.
 - Do not use the appliance as a work surface or as a storage surface.
 - If the surface of the appliance is cracked, disconnect immediately the appliance from the power supply. This to prevent an electrical shock.
 - Users with a pacemaker must keep a distance of minimum 30 cm from the induction cooking zones when the appliance is in operation.
 - When you place food into hot oil, it may splash.



WARNING!

Risk of fire and explosion

- Fats and oil when heated can release flammable vapours. Keep flames or heated objects away from fats and oils when you cook with them.
- The vapours that very hot oil releases can cause spontaneous combustion.
- Used oil, that can contain food remnants, can cause fire at a lower temperature than oil used for the first time.
- Do not put flammable products or items that are wet with flammable products in, near or on the appliance.

3.3 Use



WARNING!

Risk of injury, burns and electric shock.

- Remove all the packaging, labelling and protective film (if applicable) before first use.
 - This appliance is for household use only.
 - Do not change the specification of this appliance.
 - Make sure that the ventilation openings are not blocked.
 - Do not let the appliance stay unattended during operation.
 - Set the cooking zone to "off" after each use.
 - Do not rely on the pan detector.
- Do not keep hot cookware on the control panel.
 - Do not put a hot pan cover on the glass surface of the hob.
 - Do not let cookware boil dry.
 - Be careful not to let objects or cookware fall on the appliance. The surface can be damaged.
 - Do not activate the cooking zones with empty cookware or without cookware.
 - Do not put aluminium foil on the appliance.
 - Cookware made of cast iron, aluminium or with a damaged bottom can cause scratches on the glass / glass ceramic. Always lift these

objects up when you have to move them on the cooking surface.

- This appliance is for cooking purposes only. It must not be used for other purposes, for example room heating.

3.4 Food Sensor

- Use the Food Sensor according to its purpose. Do not use it to open or lift anything.
- Use only the Food Sensor recommended for the hob, one at a time.
- Do not use it when it is malfunctioning or damaged.
- Do not use the Food Sensor in the oven or microwave.
- The Food Sensor can read temperatures up to 120 °C.
- Make sure that the Food Sensor is always inside the food or liquid, up to the minimum level mark.
- Clean the Food Sensor before the first use. Use only neutral detergents. Do not use any abrasive products, abrasive cleaning pads, solvents or metal objects. Do not wash the Food Sensor in the dishwasher. The silicone handle may discolour, which has no effect on how the Food Sensor operates.
- Use the original packaging to store the Food Sensor.
- If you replace the Food Sensor, store the old one minimum 3 m away. The old Food Sensor may influence the functioning of the new one.

3.5 Care and cleaning

- Clean the appliance regularly to prevent the deterioration of the surface material.

- Deactivate the appliance and let it cool down before you clean it.
- Disconnect the appliance from the electrical supply before maintenance.
- Do not use water spray and steam to clean the appliance.
- Clean the appliance with a moist soft cloth. Only use neutral detergents. Do not use any abrasive products, abrasive cleaning pads, solvents or metal objects.

3.6 Service

- To repair the appliance contact the Authorised Service Centre. Use original spare parts only.
- Concerning the lamp(s) inside this product and spare part lamps sold separately: These lamps are intended to withstand extreme physical conditions in household appliances, such as temperature, vibration, humidity, or are intended to signal information about the operational status of the appliance. They are not intended to be used in other applications and are not suitable for household room illumination.

3.7 Disposal



WARNING!

Risk of injury or suffocation.

- Contact your municipal authority for information on how to discard the appliance correctly.
- Disconnect the appliance from the mains supply.
- Cut off the mains electrical cable close to the appliance and dispose of it.

4. INSTALLATION



WARNING!

Refer to Safety chapters.

4.1 Before the installation

Before you install the hob, write down the information bellow from the rating plate.

The rating plate is on the bottom of the hob.

Serial number

4.2 Built-in hobs

Only use the built-in hobs after you assemble the hob into correct built-in units and work surfaces that align to the standards.

4.3 Connection cable

- The hob is supplied with a connection cable.
- To replace the damaged mains cable, use the cable type: H05V2V2-F which withstands a temperature of 90 °C or higher. Speak to your local Service Centre.

4.4 Assembly

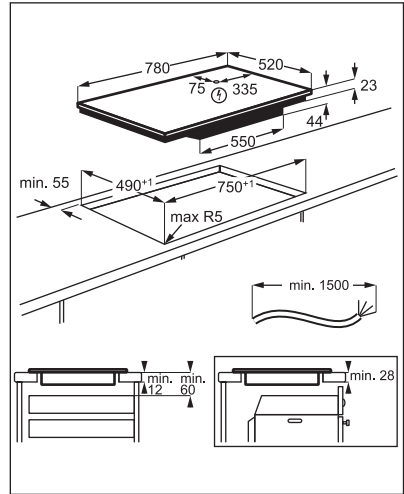
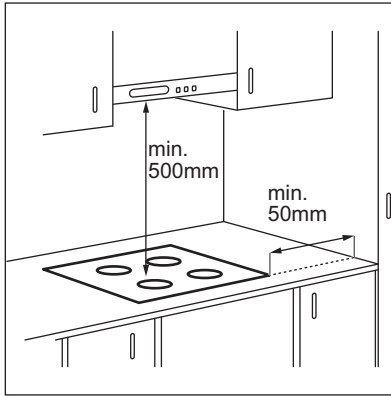

- i** If the appliance is installed above a drawer, the hob ventilation can warm up the items stored in the drawer during the cooking process.

5. PRODUCT DESCRIPTION

5.1 Cooking surface layout

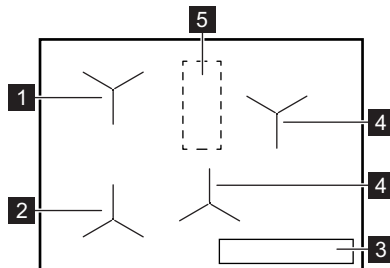







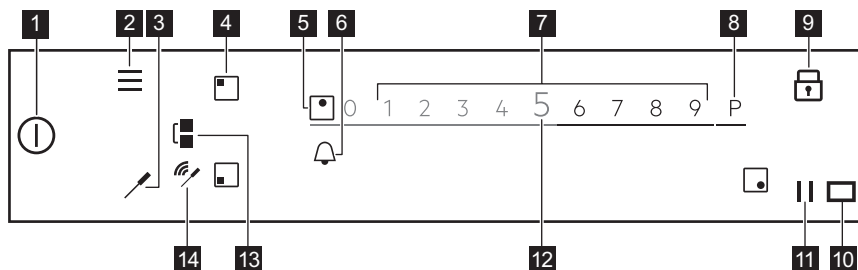





- 1 Induction zone with Assisted Cooking
- 2 Induction zone with Assisted Cooking and Pan Fry
- 3 Control panel
- 4 Induction cooking zone
- 5 Area with antenna

! **CAUTION!**
Do not put anything on the hob in this area.

5.2 Control panel layout



To see the available settings touch the appropriate symbol.

Symbol	Comment	
1 	ON / OFF	To activate and deactivate the hob.
2 	Menu	To open and close the Menu.
3 	Food Sensor	To open the Food Sensor menu.
4 	Zone selection	To open the slider for the selected zone.
5 -	Zone indicator	To show for which zone the slider is active.
6 	-	To set the timer functions.
7 -	Slider	To adjust the heat setting.
8 	PowerBoost	To activate the function.
9 	Lock	To activate and deactivate the function.
10 	-	The window of the Hob ² Hood infrared signal communicator. Do not cover it.
11 	Pause	To activate and deactivate the function.
12 	-	To show the current heat setting.
13 	Bridge	To activate and deactivate the function.
14 	Signal indicators	Full connection / No signal. To show the signal strength of the connection between the Food Sensor and the antenna.

5.3 Food Sensor

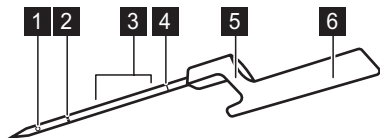

- 1** Measurement point
- 2** Minimum level mark
- 3** Recommended immersion range (for liquids)
- 4** Calibration code
- 5** Hook for placing the Food Sensor on the rim
- 6** Handle with antenna inside

The Food Sensor is a wireless temperature probe operating without a battery, delivered in a packaging with the hob. Inside its handle there is an antenna. Another antenna is located below the hob surface, in the area between the two rear cooking zones. To ensure proper communication between the Food Sensor and the hob do not put anything on the hob in this area.

The measurement point is located halfway between the tip and the minimum level mark. Insert the Food Sensor in the food at least up to the minimum level mark. For liquids, to get the best cooking results, immerse the Food Sensor in the liquid 2-5 cm above the minimum level mark. Place the Food Sensor on the rim of the pot or pan by the hook; close to the area with the antenna, at 1 - 3 o'clock position (for the left side of the hob) or 9 - 11 o'clock position (for the right side of the hob).

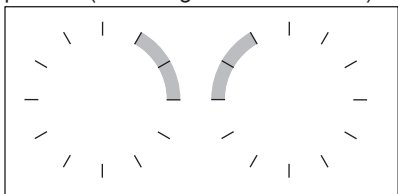

The following indicators show the strength of the connection between the hob and the Food Sensor on the display:

📶, 📶, 📶. If the hob cannot establish the connection, 📶 comes on. You can move the Food Sensor along the rim of the pot to establish or strengthen the connection. The hob refreshes the connection status every 3 seconds.

i For more information refer to "Hints and Tips for the Food Sensor".

5.4 Key features of your hob

Your new **SensePro®** hob expertly guides you through the entire cooking session. Refer to the information below to discover several of its best features.

Depending on the kind of food, you can use Assisted Cooking with or without the Food Sensor. For various dishes you get different sets of functions.

Food Sensor 🍴 - can be used in two ways. It measures the temperature in functions such as Thermometer and Pan Fry as well as helps you accurately maintain the temperature for different food types while cooking Sous Vide or using functions such as Poach, Simmer or Reheat.

Assisted Cooking - facilitates cooking by providing you with ready-made recipes for various dishes, pre-defined cooking parameters, and step-by-step instructions. You can use it with the Food Sensor, e.g. to prepare a steak, or without it, e.g. to prepare pancakes. The available options depend on the kind of dish you want to make. In this mode you can use functions such as Sous Vide, Pan Fry, Simmer, Reheat, and many more. Pop-up windows and sounds inform you when the pre-defined temperature is reached. You can access Assisted Cooking from the Menu.

Sous Vide  - a method of cooking vacuum-packed food in low temperature, for a prolonged period of time, which helps you save vitamins and maintain the flavour. Your hob provides you with clear settings and instructions to follow. Once you select the function via Assisted Cooking, the temperatures are defined for different food types. You can also choose your own temperatures if you activate the function via Sous Vide in the Menu.

Pan Fry  - a frying method with automatically controlled heat levels, dedicated to various types of food. It helps you avoid overheating of food or oil. You can activate it by selecting Assisted Cooking from the Menu.

Thermometer - with this function the Food Sensor measures the temperature while cooking. You cannot use it when the Assisted Cooking function operates.

Other useful features of your hob:

Melting  - this function is perfect for melting chocolate or butter.

PowerBoost P - this function quickly boils large quantities of water.

Pause  - this function lowers the heat setting to 1 for all cooking zones, enabling you to keep the food warm for a long time.

Bridge  - this function allows you to combine both left side zones and use

larger cookware. You can use it with Pan Fry.

Hob²Hood - this function connects the hob with a special hood and adjusts the fan speed accordingly.

Lock  - this function temporarily disables the control panel during cooking.

Child Lock - this function disables the control panel while the hob does not operate, preventing accidental use.

Stopwatch, Count Down Timer, and Minute Minder - are three functions that you can choose between to monitor the cooking time.

For more info, refer to "Daily use".

5.5 OptiHeat Control (3 step Residual heat indicator)



WARNING!

III / II / I There is a risk of burns from residual heat. The indicator shows the level of the residual heat.

The induction cooking zones produce the heat necessary for the cooking process directly in the bottom of the cookware. The glass ceramic is heated by the heat of the cookware.

6. BEFORE FIRST USE



WARNING!

Refer to Safety chapters.

6.1 Using the display







- Only the backlit symbols can be used.
- To activate a given option, touch the relevant symbol on the display.
- The selected function is activated when you remove the finger from the display.
- To scroll the available options, use a quick gesture or drag your finger across the display. The speed of the

gesture determines how fast the screen moves.

- The scrolling can stop by itself or you can stop it immediately if you touch the display.
- You can change most of the parameters shown on the display when you touch the relevant symbols.
- To select the required function or time you can scroll through the list and / or touch the option you want to choose.
- When the hob is activated and some of the symbols disappear from the

display, touch it again. All the symbols come back on.

- For certain functions, when you start them, a pop-up window with additional information appears. To deactivate the pop-up window permanently, check before you activate the function.
- Select a zone first to activate the timer functions.

Symbols useful for display navigation	
	To confirm the selection or setting.
	To go back / forwards one level in the Menu.
	To scroll up / down the instructions on the display.
	To activate / deactivate the options.
	To close the pop-up window.
	To cancel a setting.

6.2 First connection to the mains

When you connect the hob to the mains you have to set Language, Display Brightness and Buzzer Volume.

You can change the setting in Menu > Settings > Setup. Refer to "Daily use".

6.3 Food Sensor calibration

Before you start using the Food Sensor you need to calibrate it, to ensure that the temperature readings are correct.

Once the Food Sensor is calibrated properly, it measures the temperature at the boiling point with the tolerance range of + / - 2 °C.

Follow the procedure when:

- you install the hob for the first time;
- you move the hob to a different location (change of altitude);
- you replace the Food Sensor.

 Use a pot with the bottom diameter of 180 mm and fill it with 1 - 1,5 l of water.

1. To calibrate or re-calibrate the function, put the Food Sensor on the rim of a pot. Fill the pot with cold water, at least up to the minimum level mark, and place it on the left front cooking zone.
2. Touch .
Select Settings > Food Sensor > Calibration from the list.
Follow the instructions on the screen.
3. Touch Start next to the cooking zone. An info pop-up window appears once the procedure is complete.

 Do not put salt into the water, this may affect the procedure.

To leave the Menu, touch  or the right side of the display, outside of the pop-up window.

6.4 Food Sensor pairing

Originally, your hob is paired with the Food Sensor upon delivery.

If you replace the Food Sensor with a new one, you need to pair it with your hob.



1. Touch .
Select Settings > Food Sensor > Pairing from the list.
2. Touch Forget to disconnect the previous Food Sensor.
3. Touch Pair next to the cooking zone. A pop-up window appears.
4. Enter the five-digit code engraved on your new Food Sensor, using the number pad.
5. Touch OK to confirm.
Your Food Sensor is now paired with the hob.
Always calibrate the Food Sensor after pairing.

To leave the Menu, touch  or the right side of the display, outside of the pop-up window.

6.5 Menu structure

Touch  to access and change the settings of the hob or activate some functions.

To leave the Menu, touch  or the right side of the display, outside of the pop-up

window. To navigate through the Menu use  or .

The table shows the basic Menu structure.

Assisted Cooking	Refer to the Assisted Cooking section in "Daily use".		
Hob Functions	Sous Vide		
	Thermometer		
	Melting		
Settings	Child Lock		
	Stopwatch		
	Hob ² Hood	Refer to the Hob ² Hood section in "Daily use".	
	Food Sensor	Connection	
		Calibration	
		Pairing	
	Setup	Assisted Cooking	
		Language	
		Key Tones	
		Buzzer Volume	
		Display Brightness	
		Service	Demo Mode
	License		
	Show Software Version		
Alarm History			
Reset All Settings			

7. DAILY USE



WARNING!
Refer to Safety chapters.

7.1 Activating and deactivating

Touch  for 1 second to activate or deactivate the hob.

7.2 Automatic Switch Off

The function deactivates the hob automatically if:

- all cooking zones are deactivated,
- you do not set the heat setting after you activate the hob,
- you spill or put something on the control panel for more than 10 seconds (a pan, a cloth, etc.). An acoustic signal sounds and the hob deactivates. Remove the object or clean the control panel.
- the hob gets too hot (e.g. when a saucepan boils dry). Let the cooking zone cool down before you use the hob again.
- you use incorrect cookware or there is no cookware on a given zone. The white cooking zone symbol blinks and the induction cooking zone deactivates automatically after 2 minutes.
- you do not deactivate a cooking zone or change the heat setting. After some time a message comes on and the hob deactivates.

The relation between the heat setting and the time after which the hob deactivates:

Heat setting	The hob deactivates after
1 - 2	6 hours
3 - 5	5 hours
6	4 hours
7 - 9	1.5 hour

- i** When you use Pan Fry the hob deactivates after 1.5 hours. For Sous Vide the hob deactivates after 4 hours.

7.3 Using the cooking zones

Place the cookware in the centre of the selected cooking zone. Induction cooking zones adapt to the dimensions of the bottom of the cookware automatically.

Once you place a pot on the selected cooking zone the hob automatically

detects it and the relevant slider appears on the display. The slider is visible for 8 seconds, after that time the display goes back to the main view. To close the slider faster tap the screen outside of the slider area.

When other zones are active the heat setting for the zone you want to use may be limited. Refer to "Power Management".

- i** Make sure that the pot is suitable for induction hobs. For more information on cookware types refer to "Hints and tips". Check the size of the pot in "Technical data".

7.4 Heat setting

1. Activate the hob.
2. Place the pot on the selected cooking zone.
The slider for the active cooking zone appears on the display and is active for 8 seconds.
3. Touch or slide your finger to set the desired heat setting.

The symbol turns red and becomes bigger.

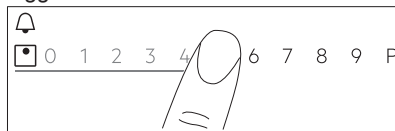

You can also change the heat setting while cooking. Touch the zone selection symbol on the main view of the control panel and move your finger to the left or right (to lower or increase the heat setting).

7.5 Bridge function

This function connects two cooking zones and they operate as one with the same heat setting.

You can use the function with large cookware.

1. Place the cookware on two cooking zones. The cookware must cover the centres of both zones.

2. Touch  to activate the function. The zone symbol changes.
3. Set the heat setting. The cookware must cover the centres of both zones but not go beyond the area marking.

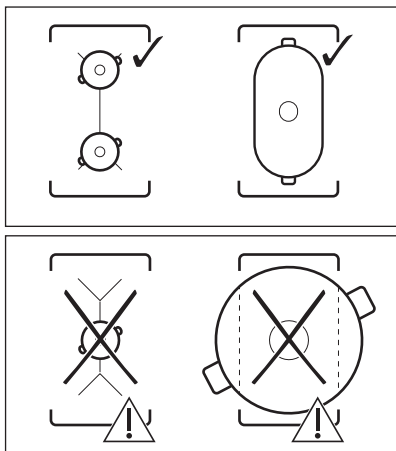

To deactivate the function, touch . The cooking zones operate independently.

7.6 PowerBoost

This function activates more power for the appropriate induction cooking zone; it depends on the cookware size. The function can be activated only for a limited period of time.

1. Touch the desired zone symbol first.
2. Touch **P** or slide your finger to the right to activate the function for the chosen cooking zone.

The symbol turns red and becomes bigger.

The function deactivates automatically.

To deactivate the function manually select the zone and change its heat setting.



For maximum duration values, refer to "Technical data".

7.7 Power Management

- Cooking zones are grouped according to the location and number of the phases in the hob. See the illustration.

- Each phase has a maximum electricity loading of 3680 W.
- The function divides the power between cooking zones connected to the same phase.
- The function activates when the total electricity loading of the cooking zones connected to a single phase exceeds 3680 W.
- The function decreases the power of the other cooking zones connected to the same phase, which has an influence on the available heat setting.
- The maximum heat setting is visible on the slider. Only the digits in white are active.
- If a higher heat setting is not available reduce it for the other cooking zones first.

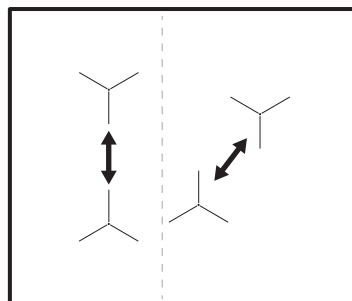

7.8 Assisted Cooking

This function adjusts the parameters to different types of food and maintains them throughout cooking.

With the function you can prepare a wide range of dishes, such as Meat, Fish & Seafood, Vegetables, Soups, Sauces, Pasta or Milk. There are different cooking methods available for different types of food, e.g. for chicken you can choose between Pan Fry, Sous Vide or Poach.

You can activate the function on the left side of the hob only. Assisted Cooking with the Sous Vide function can be activated for the left front or rear cooking zone. If you want to use Pan Fry it can be activated for the left front cooking zone or both cooking zones when bridged.



If Assisted Cooking runs on the left front cooking zone, use the zones on the right for cooking without the function.

Do not use cookware with the bottom diameter exceeding 200 mm on the left rear cooking zone when the function operates on the left front one. This may influence the connection between the Food Sensor and the antenna situated below the hob surface.

 Do not heat cookware up before cooking. Use only cold tap water or liquids, if applicable. Reheat only cold dishes.

 For Pan Fry follow the instructions on the display. Add oil once the pan is hot.

 With Assisted Cooking the timer function works as Minute Minder. It does not stop the function when the set time runs out.

1. To activate the function, touch  or  and select Assisted Cooking.
2. Choose the type of food you would like to prepare from the list. For each type of food there are a few options available. Follow the instructions shown on the display.
 - You can touch OK on top of the pop-up window to use the default settings.
 - For Pan Fry, you can change the default heat level. For some dishes you can check the core temperature of the food if you use the Food Sensor.
 - For most of the options, e.g. Sous Vide and Poach, you can change the default temperature.
 - You can change the default time or set your own. Only for Sous Vide the minimum time is pre-defined.

Additional instructions with detailed information are available on the screen.

You can scroll them with  and .

3. Touch OK. Follow the instructions in the pop-up windows.

Some of the options start with preheating. You can trace the progress on the control bar.



4. If a pop-up window appears with instructions, touch OK and then Start to continue.

The function operates with the pre-defined settings.

To deactivate the pop-up window permanently, check before you activate the function.

5. Once the set time is up, an acoustic signal sounds and a pop-up window appears. To close the window, touch OK.

The function does not stop automatically. For Sous Vide the hob will automatically deactivate after a maximum of four hours.

To stop the function, touch  or , or the symbol of the active zone, and select Stop. To confirm touch Yes in the pop-up window.

7.9 Sous Vide

To prepare meat, fish or vegetables with the use of the function you need appropriate zip-lock bags, or plastic bags and a vacuum sealer. Put seasoned food in bags and vacuum seal them. You can also buy portions of food ready to prepare with this cooking method.



WARNING!





Make sure you obey food safety principles. Refer to "Hints and Tips".

With this function you are free to choose your own time and temperature (between 35 and 85 °C), suitable for the kind of food you want to prepare. Use maximally 4 litres of water; cover the pot with a lid. For more details on cooking parameters, refer to the Cooking Guide table in "Hints and Tips". Defrost food before preparing it.

The function can only be activated for the left front or left rear cooking zone. If Sous Vide runs, use the zones on the right for cooking without the function.



With Sous Vide the timer function works as Minute Minder. The function deactivates automatically only after a maximum of four hours.





1. Prepare portions of food according to the instructions above.
 2. Place the pot filled with cold water on the left front or rear cooking zone.
 3. Touch  > Sous Vide. You can also touch  > Hob Functions > Sous Vide.
 4. Select the right temperature. Set the time (optionally). The time of the cooking session depends on the thickness and type of food.
 5. Touch OK to continue.
 6. Place the Food Sensor on the rim of the pot.
 7. Touch OK to close the pop-up window.
 8. Touch Start to activate preheating. Once the pot reaches the intended temperature, an acoustic signal sounds and a pop-up window appears. Touch OK to confirm.
 9. Put portions of food in bags vertically into the pot (you may use a Sous Vide rack). Touch Start.
- If you set the Minute Minder, it starts running along with the function.
10. Once the set time is up, an acoustic signal sounds and  blinks. To stop the signal touch .

To stop or re-adjust the function, touch  or the symbol of the active zone, and then Stop. To confirm, touch Yes in the pop-up window.

Keep Temperature

You can use the Sous Vide function for cooking while the Food Sensor accurately controls and maintains the temperature (with the accuracy of + / - 1 °C). You can prepare a wide range of dishes such as spiced fondos or sauces (e.g. different types of curry or bouillabaisse). You can set your own parameters or refer to the Cooking Guide table in "Hints and Tips".

The function can only be activated for the left front or left rear cooking zone.

1. Touch  > Hob Functions > Sous Vide or access the function by touching  > Sous Vide.
 2. Select the right temperature. Set the time (optionally).
 3. Touch OK to continue.
 4. Place the Food Sensor on the rim of the pot, or insert it in the food.
 5. Touch Start to activate preheating. Once the pot reaches the intended temperature, an acoustic signal sounds and a pop-up window appears.
 6. Touch OK to close the pop-up window.
 7. Touch Start.
- If you set the Minute Minder, it starts running along with the function.
8. Once the set time is up, an acoustic signal sounds and  blinks. To stop the signal touch .



To stop or re-adjust the function, touch  or the symbol of the active zone, and then Stop. To confirm, touch Yes in the pop-up window.

7.10 Thermometer

With this function the Food Sensor works as a thermometer, which helps you monitor the temperature of the food or liquid while cooking. For example, you can rely on it to heat up milk or check the temperature of baby food.

At least one cooking zone has to be active to use the function.

You can activate the function for all cooking zones but only for one cooking zone at a time.

1. Insert the Food Sensor inside the food or liquid up the minimum level mark.
2. Touch  on the display to open the Food Sensor menu and choose Thermometer. You can also touch  > Hob Functions > Thermometer.
3. Touch Start. Measuring starts on the active cooking zone. If none of the cooking zones is active an info pop-up window appears.

To stop the function, touch the digits indicating the temperature or  and select Stop.

7.11 Melting

You can use this function to melt different products, e.g. chocolate or butter. You can use the function only for one cooking zone at a time.

1. Touch  on the display to open the Menu.
2. Select Hob Functions > Melting from the list.
3. Touch Start.

You need to select the desired cooking zone.

If the cooking zone is already active a pop-up window appears. Cancel the previous heat setting to activate the function.



To leave the Menu, touch  or the right side of the display, outside of the pop-up window. To navigate through the Menu, use < or >.

To stop the function, touch the zone selection symbol and then touch Stop.

7.12 || Pause

This function sets all cooking zones that operate to the lowest heat setting.

You cannot activate the function when Assisted Cooking or Sous Vide is running.

When the function operates only  and  symbols can be used. All other symbols on the control panel are locked.

The function does not stop the timer functions.

Touch  to activate the function.

 comes on. The heat setting is lowered to 1.

To deactivate the function touch .

The function stops PowerBoost. The highest heat setting reactivates when you touch  again.

7.13 Timer

Count Down Timer

Use this function to specify how long a cooking zone should operate during a single cooking session.

You can set the function for each cooking zone separately.

1. Set the heat setting for the appropriate cooking zone first and then set the function.
2. Touch the zone symbol.

3. Touch .



The timer menu window appears on the display.



4. Check  to activate the function.

The symbols change to  .

5. Slide your finger to the left or right to select the desired time (e.g. hours and/or minutes).
6. Touch OK to confirm your selection.

You can also choose  to cancel your selection.

When the time comes to an end, a signal sounds and  blinks. Touch  to stop the signal.

To deactivate the function set the heat setting to 0. Alternatively, touch  to the left of the timer value, touch  next to it and confirm your choice when a pop-up window appears.

Minute Minder

You can use this function when the hob is activated but the cooking zones do not operate.



The function has no effect on the operation of the cooking zones.

1. Select any cooking zone. The relevant slider appears on the display.

2. Touch .

The timer menu window appears on the display.

3. Slide your finger to the left or right to select the desired time (e.g. hours and minutes).
4. Touch OK to confirm your selection.



You can also choose **X** to cancel your selection. When the time comes to an end, a signal sounds and  blinks. Touch  to stop the signal.

To deactivate the function touch  to the left of the timer value, touch **X** next to it and confirm your choice when a pop-up window appears.

Stopwatch

The function automatically starts counting immediately after you activate a cooking zone. You can use this function to monitor how long it operates.

1. Touch  to access the Menu.
2. Scroll the Menu to select Settings > Stopwatch.
3. Touch the switch to turn the function on / off.

The function does not stop when you lift the pot. To reset the function and start it again manually touch , select Reset from the pop-up window. The function starts counting from 0. To Pause the function for one cooking session touch  and select Pause from the pop-up window. Select Start to continue counting.

7.14 Lock

You can lock the control panel while the hob operates. It prevents an accidental change of the heat setting.

Set the heat setting first.

Touch  to activate the function.

To deactivate the function, touch  for 3 seconds.



When you deactivate the hob, you also deactivate this function.

7.15 Child Lock

This function prevents an accidental operation of the hob.

1. Touch  on the display to open the Menu.

2. Select Settings > Child Lock from the list.
3. Turn the switch on and touch the letters A-O-X in the alphabetical order to activate the function. To deactivate the function turn the switch off.

To leave the Menu, touch  or the right side of the display, outside of the pop-up window. To navigate through the Menu, use < or >.

7.16 Language

1. Touch  on the display to open the Menu.
2. Select Settings > Setup > Language from the list.
3. Choose the appropriate language from the list.

If you chose the wrong language, touch . A list appears. Select the third option from the top, then the last but one option. Next, select the second option. Scroll down to choose the appropriate language from the list. Finally, choose the option on the right.

To leave the Menu, touch  or the right side of the display, outside of the pop-up window. To navigate through the Menu, use < or >.

7.17 Key Tones / Buzzer Volume

You can choose the type of sound your hob emits or turn the sounds off entirely. You can choose between the click (default) or beep.

1. Touch  on the display to open the Menu.
2. Select Settings > Setup > Key Tones / Buzzer Volume from the list.
3. Choose the appropriate option.

To leave the Menu, touch  or the right side of the display, outside of the pop-up window. To navigate through the Menu, use < or >.

7.18 Display Brightness

You can change the brightness of the display.

There are 4 brightness levels, 1 is the lowest and 4 is the highest.

1. Touch  on the display to open the Menu.
2. Select Settings > Setup > Display Brightness from the list.
3. Choose the appropriate level.

To leave the Menu, touch  or the right side of the display, outside of the pop-up window. To navigate through the Menu, use < or >.

7.19 Hob²Hood

It is an advanced automatic function which connects the hob to a special hood. Both the hob and the hood have an infrared signal communicator. The speed of the fan is defined automatically on the basis of the mode setting and the temperature of the hottest pot on the hob.

For most of the hoods the remote system is originally deactivated. Activate it before you use the function. For more information refer to the hood user manual.

To operate the function automatically, set the automatic mode to H1 - H6. The hob is originally set to H5. The hood reacts whenever you operate the hob. The hob recognizes the temperature of the cookware automatically and adjusts the speed of the fan. You can set the hob to activate only the light by selecting H1.



If you change the fan speed on the hood, the default connection with the hob is deactivated. To reactivate the function, turn both appliances OFF and ON again.

Mode	Automatic light	Boiling ¹⁾	Frying ²⁾
H0	Off	Off	Off
H1	On	Off	Off
H2 ³⁾	On	Fan speed 1	Fan speed 1
H3	On	Off	Fan speed 1
H4	On	Fan speed 1	Fan speed 1
H5	On	Fan speed 1	Fan speed 2
H6	On	Fan speed 2	Fan speed 3

¹⁾ The hob detects the boiling process and activates fan speed in accordance with the automatic mode.

²⁾ The hob detects the frying process and activates fan speed in accordance with the automatic mode.

³⁾ This mode activates the fan and the light and does not rely on the temperature.

Changing the modes

If you are not satisfied with the noise level / fan speed, you can switch between modes manually.

1. Touch . Select Settings > Hob²Hood from the list.
2. Choose the appropriate mode.

To leave the Menu touch  or the right side of the display, outside of the pop-up window.

When you finish cooking and deactivate the hob, the hood fan may still operate for a certain period of time. After that time the system deactivates the fan automatically and prevents you from an accidental activation for the next 30 seconds.

The light on the hood deactivates 2 minutes after deactivating the hob.

8. HINTS AND TIPS



WARNING!
Refer to Safety chapters.

8.1 Cookware

i For induction cooking zones a strong electro-magnetic field creates the heat in the cookware very quickly.

i Use the induction cooking zones with suitable cookware.

Cookware material

- **correct:** cast iron, steel, enamelled steel, stainless steel, multi-layer bottom (with a correct marking from a manufacturer).
- **not correct:** aluminium, copper, brass, glass, ceramic, porcelain.

Cookware is suitable for an induction hob if:

- water boils very quickly on a zone set to the highest heat setting.
- a magnet pulls on to the bottom of the cookware.

i The bottom of the cookware must be as thick and flat as possible. Ensure pan bases are clean and dry before placing on the hob surface.

Cookware dimensions

Induction cooking zones adapt to the dimension of the bottom of the cookware automatically.

The cooking zone efficiency is related to the diameter of the cookware. The cookware with a diameter smaller than the minimum receives only a part of the power generated by the cooking zone.

i Refer to "Technical data".

8.2 Correct pans for Pan Fry function

Use only pans with flat bottom. To check if the pan is correct:

1. Put your pan upside down.
2. Put a ruler on the bottom of the pan.
3. Try to put a coin of 1, 2 or 5 Euro Cent (or with similar thickness)

between the ruler and the bottom of the pan.

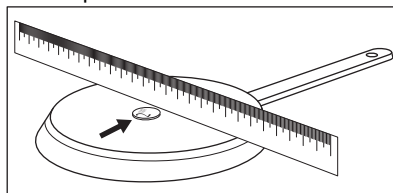

a. The pan is incorrect if you can put the coin between the ruler and the pan.

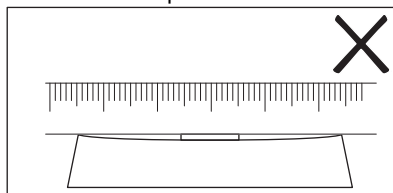

b. The pan is correct if you cannot put the coin between the ruler and the pan.

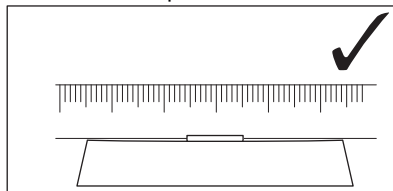

8.3 The noises during operation

If you can hear:

- crack noise: cookware is made of different materials (a sandwich construction).
- whistle sound: you use a cooking zone with a high power level and the cookware is made of different materials (a sandwich construction).
- humming: you use a high power level.
- clicking: electric switching occurs, the pot is detected after you place it on the hob.
- hissing, buzzing: the fan operates.

The noises are normal and do not indicate any malfunction.

8.4 Öko Timer (Eco Timer)

To save energy, the heater of the cooking zone deactivates before the

count down timer sounds. The difference in the operation time depends on the heat setting level and the length of the cooking operation.

8.5 Examples of cooking applications

The correlation between the heat setting of a zone and its consumption of power

is not linear. When you increase the heat setting, it is not proportional to the increase of the consumption of power. It means that a cooking zone with the medium heat setting uses less than a half of its power.



The data in the table is for guidance only.

Heat setting	Use to:	Time (min)	Hints
1	Keep cooked food warm.	as necessary	Put a lid on the cookware.
1 - 2	Hollandaise sauce, melt: butter, chocolate, gelatine.	5 - 25	Mix from time to time.
1 - 2	Solidify: fluffy omelettes, baked eggs.	10 - 40	Cook with a lid on.
2 - 3	Simmer rice and milkbased dishes, heat up ready-cooked meals.	25 - 50	Add at least twice as much liquid as rice, mix milk dishes halfway through the procedure.
3 - 4	Steam vegetables, fish, meat.	20 - 45	Add a couple of tablespoons of liquid.
4 - 5	Steam potatoes.	20 - 60	Use max. ¼ l of water for 750 g of potatoes.
4 - 5	Cook larger quantities of food, stews and soups.	60 - 150	Up to 3 l of liquid plus ingredients.
6 - 7	Gentle fry: escalope, veal cor-don bleu, cutlets, rissoles, sausages, liver, roux, eggs, pancakes, doughnuts.	as necessary	Turn halfway through.
7 - 8	Heavy fry, hash browns, loin steaks, steaks.	5 - 15	Turn halfway through.
9	Boil water, cook pasta, sear meat (goulash, pot roast), deep-fry chips.		
P	Boil large quantities of water. PowerBoost is activated.		

8.6 Hints and Tips for the Food Sensor

- i** For functions such as Assisted Cooking and Sous Vide, you can use the Food Sensor on the left side of the hob only. With the Thermometer function you can use the Food Sensor also on the right side of the hob.

To ensure strong connection (📶, 📶) between the Food Sensor and the hob:

For liquids

- Immerse the Food Sensor in the liquid, within the recommended immersion range. The minimum level mark has to be covered.
- Place the Food Sensor on the rim of the pot. If possible, keep it in the vertical position. Make sure its tip comes into contact with the bottom of the pot. The handle of the Food Sensor should always be outside of the pot or pan.

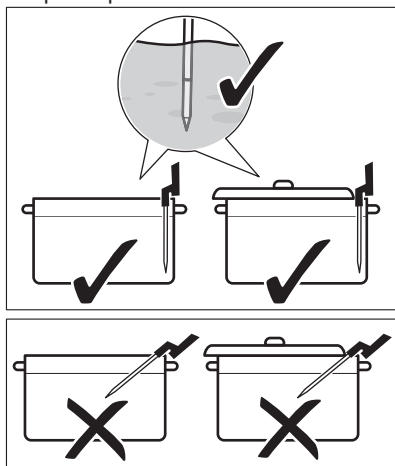

- If you want to use the Food Sensor on the left side of the hob, ensure that it is near the centre of the hob, at 1 - 3 o'clock position. If you want to use it on the right (with the Thermometer function), make sure it is placed at 9 - 11 o'clock position. Refer to the illustrations below.

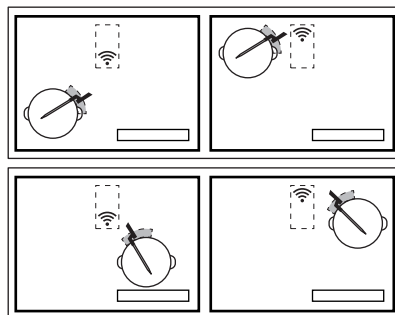

You can move the Food Sensor along the rim of the pot if the connection fails to establish.

- You can partially cover the pot with a lid.
- If you use the left front cooking zone, do not place any large pots on the left rear one. Large pots on the left rear cooking zone may block the signal. Move the large pot to the right rear cooking zone.

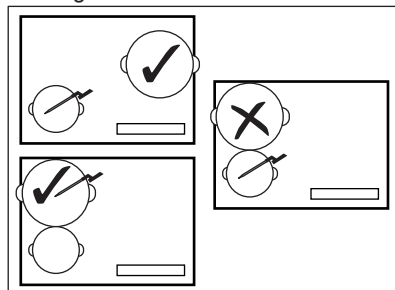

For solid foods (core temperature measurement)

- Insert the Food Sensor across the thickest part of the food, up to the minimum level mark. The measurement point should be in the central part of the portion.

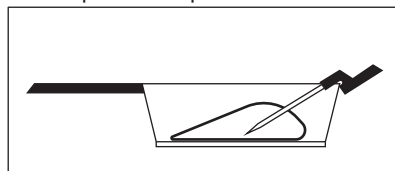

- Make sure the Food Sensor is firmly inserted in the food. The metal parts of the Food Sensor should not touch the walls of the pot / pan. The hook of the handle has to point downwards.

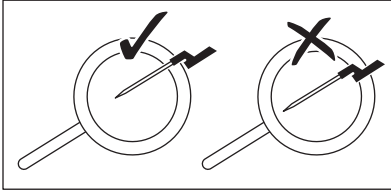

- For meat / fish with a thickness of 2 - 3 cm, the tip of the Food Sensor should reach the bottom of the pan.
- Remove the Food Sensor before turning the food over.
- When using a plancha, make sure the handle of the Food Sensor stays on the right side, outside of its surface. Refer to the illustrations below.

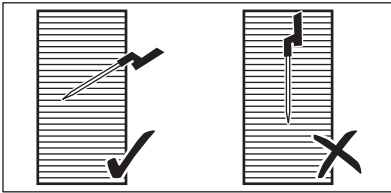

8.7 Cooking at low temperatures - Food safety principles

Make sure you comply with the following instructions when cooking at low temperatures, e.g. Sous Vide.

- Wash / disinfect your hands before preparing food. Use disposable gloves.
- Use only high quality fresh food, stored in appropriate conditions.
- Always wash and peel fruits and vegetables thoroughly.
- Keep your worktop surface and cutting boards clean. Use different

cutting boards for different types of food.

- Pay special attention to food hygiene when preparing poultry, eggs, and fish. Poultry should always be prepared at the temperature of at least 65 °C for a minimum of 50 minutes.
- Make sure the fish you want to prepare with the use of Sous Vide have the sashimi quality, i.e. it is extra fresh.
- Store the prepared food in a refrigerator for a maximum of 24 hours.
- For people with a weakened immune system or chronic health conditions it is advisable to pasteurise food before consuming it. Pasteurise the food at 60 °C for a minimum of one hour.

8.8 Cooking Guide

The table below shows examples of food types and provides you with the optimal temperatures and suggested cooking times. The parameters may vary depending on the temperature, quality, consistency, and quantity of food.

The length of the cooking time depends more on the thickness of the food than on its weight. E.g. for steak, the thicker the piece, the more time it takes for its core to reach the pre-defined temperature. A 2 cm-thick steak requires around one hour to reach 58 °C, while a 5 cm-thick one needs around four hours.

Monitor the first cooking session to ensure the parameters below suit your cooking habits and cookware. You can change these parameters depending on your personal preferences.

Food type	Cooking method	Preparation level	Thickness / amount of food	Core temp / cooking temp (°C)	Cooking time (min)
Beef - steak	Sous Vide	rare	2 cm	50 - 54	45 - 90
			4 cm		100 - 150
			6 cm		180 - 250
		medium	2 cm	55 - 60	45 - 90
			4 cm		100 - 150
			6 cm		180 - 250
		done	2 cm	61 - 68	45 - 90
			4 cm		100 - 150
			6 cm		180 - 250
Chicken - breast	Sous Vide	well-done	200 - 300 g	64 - 72	45 - 60
	Poach	well-done		68 - 74	35 - 45
Chicken - leg	Poach	well-done	200 - 300 g	78 - 85	30 - 60
Pork - steak	Sous Vide	well-done	2 cm	60 - 66	35 - 60
Pork - tenderloin	Sous Vide	well-done	4 - 5 cm	62 - 66	60 - 120
Lamb fillet	Sous Vide	medium	2 cm	56 - 60	35 - 60
		well-done		64 - 68	40 - 65
Saddle of lamb (without bones)	Sous Vide	medium	200 - 300 g	56 - 60	60 - 120
		well-done		64 - 68	65 - 120
Salmon	Sous Vide	translucent	2 cm	46 - 52	20 - 45
			3 cm	46 - 52	35 - 50
	Poach	translucent	2 cm	55 - 68	20 - 35
			3 cm	55 - 68	25 - 45
Tuna	Sous Vide	translucent	2 cm	45 - 50	35 - 50
Shrimps	Sous Vide	translucent	1 - 2 cm	50 - 56	25 - 45

Food type	Cooking method	Preparation level	Thickness / amount of food	Core temp / cooking temp (°C)	Cooking time (min)
Eggs	Sous Vide	soft ¹⁾	M - size	63 - 64	45 - 70 ²⁾
		medium ¹⁾		65 - 67	45 - 70 ²⁾
		hard ¹⁾		68 - 70	45 - 70 ²⁾
	Boiling	soft		boiling	4
		medium		boiling	7
		hard		boiling	10
Rice	Swelling	cooked	-	-	10 - 30
Potatoes	Boiling	cooked	-	-	15 - 30
Vegetables (fresh)	Sous Vide	cooked	-	85	30 - 40
Asparagus	Sous Vide	cooked	-	85	30 - 40

¹⁾ The egg white stays liquid.

²⁾ The times are for medium-sized eggs. For large eggs and eggs from the fridge add one minute to the cooking time.

Additional tips for Assisted Cooking:

- Fill the pot with a suitable amount of liquid (i.e. between 1 - 3 litres) before cooking. Try to avoid adding more while cooking.
- Use a lid to save energy and reach the temperature faster (also for preheating water).
- Stir your dish regularly throughout the cooking process to ensure a uniform temperature distribution.
- Add salt at the very beginning of a cooking session.
- Defrost food before preparing it.
- Add vegetables (e.g. broccoli, cauliflower, green beans, Brussels sprouts) when the water reaches the intended temperature and the pop-up window appears.
- Add potatoes or rice to cold water before you start the function.
- For stews, sauces, soups, curries, ragout, goulash, and broths you can use Reheat or Simmer. Before you start the Simmer function, fry the ingredients (without the Food Sensor)

and add cold liquid; next, activate the function from Assisted Cooking.

- For small seafood, e.g. octopus slices / tentacles or shellfish you can use Pan Fry.

Additional tips for Pan Fry:



WARNING!

Use only pans with flat bottoms.



CAUTION!

Use laminated pans only with low heat setting levels, to prevent overheating and damage of the cookware.

- Start the function when the hob is cold (no preheating is necessary).
- Use sandwich bottom cookware made of stainless steel.
- Do not use cookware with an embossment in the centre of the bottom.
- Different sizes of pans can cause different heat up times. Heavy pans store more heat than the lighter ones and take more time to heat up.

- Turn the food over once it reaches a half of the desired temperature. Very thick portions of food should be turned over more often (i.e. once every two minutes). We recommend you use the Sous Vide method first, to get best results. To add a finishing touch, put the prepared portions on a pre-heated pan and roast them quickly on both sides.
- Always remove the Food Sensor before turning the food over.

8.9 Hints and Tips for Hob²Hood

When you operate the hob with the function:

- Protect the hood panel from direct sunlight.
- Do not spot halogen light on the hood panel.
- Do not cover the hob control panel.
- Do not interrupt the signal between the hob and the hood (e.g. with the hand, a cookware handle or a tall pot). See the picture.

The hood in the picture is only exemplary.

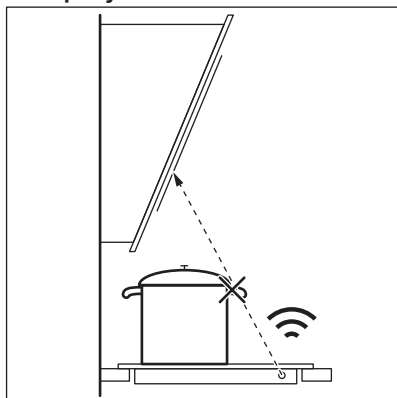

Keep the window of the Hob²Hood infrared signal communicator clean.



Other remotely controlled appliances may block the signal. Do not use any such appliances near to the hob while Hob²Hood is on.

Cooker hoods with the Hob²Hood function

To find the full range of cooker hoods which work with this function refer to our consumer website. The AEG cooker hoods that work with this function must have the symbol .

9. CARE AND CLEANING



WARNING!
Refer to Safety chapters.

9.1 General information

- Clean the hob after each use.

- Always use cookware with a clean base.
- Scratches or dark stains on the surface have no effect on how the hob operates.
- Use a special cleaner suitable for the surface of the hob.

- Use a special scraper for the glass.

9.2 Cleaning the hob

- **Remove immediately:** melted plastic, plastic foil, sugar and food with sugar, otherwise, the dirt can cause damage to the hob. Take care to avoid burns. Use a special hob scraper on the glass surface at an acute angle and move the blade on the surface.
- **Remove when the hob is sufficiently cool:** limescale rings, water rings, fat stains, shiny metallic discoloration. Clean the hob with a moist cloth and a non-abrasive detergent. After cleaning, wipe the hob dry with a soft cloth.
- **Remove shiny metallic discoloration:** use a solution of water with vinegar and clean the glass surface with a cloth.
- The surface of the hob has horizontal grooves. Clean the hob with a moist cloth and some detergent with smooth movement from left to right. After cleaning, wipe the hob dry with a soft cloth from left to right.

10. TROUBLESHOOTING







WARNING!
Refer to Safety chapters.

10.1 What to do if...

Problem	Possible cause	Remedy
You cannot activate or operate the hob.	The hob is not connected to an electrical supply or it is connected incorrectly.	Check if the hob is correctly connected to the electrical supply. Refer to the connection diagram.
	The fuse is blown.	Make sure that the fuse is the cause of the malfunction. If the fuse is blown again and again, contact a qualified electrician.
	You do not set the heat setting for 60 seconds.	Activate the hob again and set the heat setting in less than 60 seconds.
The display does not react to the touch.	You touched 2 or more sensor fields at the same time.	Touch only one sensor field.
	Pause operates.	Refer to "Daily use".
	Part of the display is covered or the pots are placed too near to the display. There is some liquid or an object on the display.	Remove the objects. Move the pots away from the display. Clean the display, wait until the appliance is cold. Disconnect the hob from the electrical supply. After 1 min, connect the hob again.

Problem	Possible cause	Remedy
An acoustic signal sounds and the hob deactivates. An acoustic signal sounds when the hob is deactivated.	You put something on one or more sensor fields.	Remove the object from the sensor fields.
The hob deactivates.	You put something on the sensor field ①.	Remove the object from the sensor field.
Residual heat indicator does not come on.	The zone is not hot because it operated only for a short time or the sensor under the hob surface is damaged.	If the zone operated sufficiently long to be hot, speak to an Authorised Service Centre.
After you activate Assisted Cooking, the hob starts heating up, stops, and then starts again.	This is a safety check to ensure that the Food Sensor is in a pot for which the Assisted Cooking function was activated.	It is a normal procedure, it does not indicate any malfunction.
You cannot activate the highest heat setting.	Another zone is already set to the highest heat setting.	First reduce the power of the other zone.
The sensor fields become hot.	The cookware is too large or you put it too near to the controls.	Put large cookware on the rear zones if possible.
The display shows that the Food Sensor is not found.	The position of the Food Sensor is incorrect. Something blocks its signal (e.g. cutlery, a pan handle or another pot).	Position the Food Sensor correctly. Refer to the illustrations in the "Hints and tips" section. Remove any metal objects or other objects that may block the signal.
The display shows the temperature of water is higher than 100°C.	You did not calibrate the Food Sensor or you did it incorrectly. You moved the hob to a different location.	Calibrate the Food Sensor again. Refer to "Calibrating". You may also need to check if the calibration code is correct. Refer to "Pairing".
	You put too much salt in the water.	Do not salt boiling water.
Temperature is not visible on the display. The display shows a warning icon.	The Food Sensor did not establish connection with the hob because the strength of the signal is too low.	Place the Food Sensor close to the antenna on the hob surface, near the centre of the hob. Refer to "Hints and tips".

Problem	Possible cause	Remedy
	Something covers the Food Sensor or the antenna on the hob surface, e.g. a piece of metal cutlery.	Remove anything that covers the antenna. Make sure you place cookware in the centre of the cooking zone. Refer to "Hints and tips".
	The connection between the Food Sensor and the antenna was lost.	Make sure nothing covers the signal. Move the Food Sensor along the rim of the pot to adjust its position. Refer to "Hints and tips".
	Other appliances work at the same frequency and disturb the connection.	Remove any appliances that may disturb the connection. Refer to "Technical Data".
Temperature of the food is different than expected.	The Food Sensor is inserted incorrectly.	Make sure the measurement point is situated in the thickest part of the food. Refer to the illustrations in the "Hints and tips" section.
The hob detects significant temperature jumps.	You added some water or changed the pot while cooking.	Avoid adding water or changing the pot after a function starts.
	The heat in the pot did not spread evenly, especially for thick liquids.	Stir the food frequently.
The pot gets too hot or the food is overdone too quickly.	You used a pot which is too small.	Use pots whose sizes are appropriate for a given cooking zone. Refer to "Technical data".
You cannot activate a function.	Another function is running on the same cooking zone, which prevents the activation.	Stop the function before you activate another.
Assisted Cooking or Sous Vide stops.	At the beginning of a cooking session the temperature of the liquid inside the pot is higher than 40 °C. The cookware in use is hot.	Use only cold liquids. Do not preheat the cookware.
Hob ² Hood does not work.	You covered the control panel.	Remove the object from the control panel.
Hob ² Hood operates, but only the light is on.	You activated the H1 mode.	Change the mode to H2 - H6 or wait until the automatic mode starts.

Problem	Possible cause	Remedy
Hob [®] Hood modes H1 - H6 operate, but the light is off.	There might be a problem with the light bulb.	Contact an Authorised Service Centre.
There is no sound when you touch the panel sensor fields.	The sounds are deactivated.	Activate the sounds. Refer to "Daily use".
Wrong language is set.	You changed the language by mistake.	Reset all functions to the factory settings. Select Reset All Settings from the Menu. Disconnect the hob from the electrical supply. After 1 min, connect the hob again. Set Language, Display Brightness and Buzzer Volume.
A cooking zone deactivates. A warning message saying the cooking zone is going to switch off comes on.	Automatic Switch Off deactivates the cooking zone.	Refer to "Daily use". Deactivate the hob and activate it again.
 and a message come on.	Lock operates.	Refer to "Daily use".
O - X - A appears.	Child Lock operates.	Refer to "Daily use".
 blinks.	There is no cookware on the zone.	Put cookware on the zone.
	The cookware is unsuitable.	Use suitable cookware. Refer to "Hints and tips".
	The diameter of the bottom of the cookware is too small for the zone.	Use cookware with correct dimensions. Refer to "Technical data".
 and a number come on.	There is an error in the hob.	Deactivate the hob and activate it again after 30 seconds. If  comes on again, disconnect the hob from the electrical supply. After 30 seconds, connect the hob again. If the problem continues, speak to an Authorised Service Centre.
You can hear a constant beep noise.	The electrical connection is incorrect.	Disconnect the hob from the electrical supply. Ask a qualified electrician to check the installation.

10.2 If you cannot find a solution...

If you cannot find a solution to the problem yourself, contact your dealer or an Authorised Service Centre. Give the data from the rating plate. Make sure, you operated the hob correctly. If not the

servicing by a service technician or dealer will not be free of charge, also during the warranty period. The instructions about the Service Centre and conditions of guarantee are in the guarantee booklet.

11. TECHNICAL DATA

11.1 Rating plate

Model IAE84881FB
Typ 62 D4A 01 CA
Induction 7.35 kW
Ser.Nr.
AEG

PNC 949 597 485 00
220 - 240 V / 400 V 2N 50 - 60 Hz
Made in Germany
7.35 kW



11.2 Software Licences

The software included in the hob contains copyrighted software that is licensed under the BSD, fontconfig, FTL, GPL-2.0, LGPL-2.0, LGPL-2.1, libJpeg, zLib/ libpng, MIT, OpenSSL / SSLEAY ISC, Apache 2.0 and others.

Check the full copy of the licence in: Menu > Settings > Service > License.

You can download the source code of the open source software by following the hyperlink present in the web product page.

11.3 Cooking zones specification

Cooking zone	Nominal power (maximum heat setting) [W]	PowerBoost [W]	PowerBoost maximum duration [min]	Cookware diameter [mm]
Left front	2300	3200	10	125 - 210
Left rear	2300	3200	10	125 - 210
Middle front	1400	2500	4	125 - 145
Right rear	2300	3600	10	205 - 240

The power of the cooking zones can be different in some small range from the data in the table. It changes with the material and dimensions of the cookware.

For optimal cooking results use cookware no larger than the diameter in the table.

11.4 Food Sensor Technical Specifications

Food Sensor is approved for use in contact with food.

Working frequency	433,05 - 434,73 MHz
Maximum sending power	5 dBm

Temperature range	0 - 120°C
-------------------	-----------

Measurement cycle	3 seconds
-------------------	-----------

12. ENERGY EFFICIENCY

12.1 Product information according to EU 66/2014 valid for EU market only

Model identification		IAE84881FB
Type of hob		Built-In Hob
Number of cooking zones		4
Heating technology		Induction
Diameter of circular cooking zones (Ø)	Left front	21.0 cm
	Left rear	21.0 cm
	Middle front	14.5 cm
	Right rear	24.0 cm
Energy consumption per cooking zone (EC electric cooking)	Left front	179.6 Wh / kg
	Left rear	189.1 Wh / kg
	Middle front	180.2 Wh / kg
	Right rear	185.2 Wh / kg
Energy consumption of the hob (EC electric hob)		183.5 Wh / kg

EN 60350-2 - Household electric cooking appliances - Part 2: Hobs - Methods for measuring performance

The energy measurements referring to the cooking area are identified by the markings of the respective cooking zones.

12.2 Energy saving

You can save energy during everyday cooking if you follow below hints.

- When you heat up water, use only the amount you need.
- If it is possible, always put the lids on the cookware.
- Before you activate the cooking zone put the cookware on it.
- Put the smaller cookware on the smaller cooking zones.
- Put the cookware directly in the centre of the cooking zone.
- Use the residual heat to keep the food warm or to melt it.

13. WARRANTY

FOR SALES IN AUSTRALIA AND NEW ZEALAND

ALL AEG BRANDED APPLIANCES

This document sets out the terms and conditions of the product warranties for AEG Appliances. It is an important document. Please keep it with your proof of purchase documents in a safe place for future reference should

there be a manufacturing defect in your Appliance. This warranty is in addition to other rights you may have under the Australian Consumer Law.

1. **In this warranty:**
 - a) 'ACL' or 'Australian Consumer Law' means Schedule 2 to the Competition and Consumer Act 2010;

- b) 'Appliance' means any Electrolux product purchased by you and accompanied by this document;
- c) 'ASC' means Electrolux's authorised serviced centres;
- d) 'AEG' is the brand controlled by Electrolux Home Products Pty Ltd of 163 O'Riordan Street, Mascot NSW 2020, ABN 51 004 762 341 in respect of Appliances purchased in Australia and Electrolux (NZ) Limited (collectively "Electrolux") of 3-5 Niall Burgess Road, Mount Wellington, in respect of Appliances purchased in New Zealand;
- e) 'Warranty Period' means the period specified in clause 3 of this warranty;
- f) 'you' means the purchaser of the Appliance not having purchased the Appliance for re-sale, and 'your' has a corresponding meaning.
2. **Application:** This warranty only applies to new Appliances, purchased and used in Australia or New Zealand and is in addition to (and does not exclude, restrict, or modify in any way) other rights and remedies under a law to which the Appliances or services relate, including any non-excludable statutory guarantees in Australia and New Zealand.
3. **Warranty Period:** Subject to these terms and conditions, this warranty continues for in Australia for a period of 60 months and in New Zealand for a period of 60 months, following the date of original purchase of the Appliance.
4. **Repair or replace warranty:** During the Warranty Period, Electrolux or its ASC will, at no extra charge if your Appliance is readily accessible for service, without special equipment and subject to these terms and conditions, repair or replace any parts which it considers to be defective. Electrolux may, in its absolute discretion, choose whether the remedy offered for a valid warranty claim is repair or replacement. Electrolux or its ASC may use refurbished parts to repair your Appliance. You agree that any replaced Appliances or parts become the property of Electrolux.
5. **Travel and transportation costs:** Subject to clause 7, Electrolux will bear the reasonable cost of transportation, travel and delivery of the Appliance to and from Electrolux or its ASC. Travel and transportation will be arranged by Electrolux as part of any valid warranty claim.
6. **Proof of purchase** is required before you can make a claim under this warranty.
7. **Exclusions:** You may not make a claim under this warranty unless the defect claimed is due to faulty or defective parts or workmanship. This warranty does not cover:
- light globes, batteries, filters or similar perishable parts;
 - parts and Appliances not supplied by Electrolux;
 - cosmetic damage which does not affect the operation of the Appliance;
 - damage to the Appliance caused by:
 - negligence or accident;
 - misuse or abuse, including failure to properly maintain or service;
 - improper, negligent or faulty servicing or repair works done by anyone other than an Electrolux authorised repairer or ASC;
 - normal wear and tear;
 - power surges, electrical storm damage or incorrect power supply;
 - incomplete or improper installation;
 - incorrect, improper or inappropriate operation;
 - insect or vermin infestation;
 - failure to comply with any additional instructions supplied with the Appliance;
- In addition, Electrolux is not liable under this warranty if:
- the Appliance has been, or Electrolux reasonably believes that the Appliance has been, used for purposes

- other than those for which the Appliance was intended, including where the Appliance has been used for any non-domestic purpose;
- the Appliance is modified without authority from Electrolux in writing;
 - the Appliance's serial number or warranty seal has been removed or defaced.
8. **How to claim under this warranty:** To enquire about claiming under this warranty, please follow these steps:
- a. carefully check the operating instructions, user manual and the terms of this warranty;
 - b. have the model and serial number of the Appliance available;
 - c. have the proof of purchase (e.g. an invoice) available;
 - d. telephone the numbers shown below.
9. **Australia:** For Appliances and services provided by Electrolux in Australia: Electrolux goods come with guarantees that cannot be excluded under the Australian Consumer Law. You are entitled to a replacement or
- refund for a major failure and for compensation for any other reasonably foreseeable loss or damage. You are also entitled to have the Appliance repaired or replaced if the Appliance fails to be of acceptable quality and the failure does not amount to a major failure. 'Acceptable quality' and 'major failure' have the same meaning as referred to in the ACL.
10. **New Zealand:** For Appliances and services provided by Electrolux in New Zealand, the Appliances come with a guarantee by Electrolux pursuant to the provisions of the Consumer Guarantees Act, the Sale of Goods Act and the Fair Trading Act. Where the Appliance was purchased in New Zealand for commercial purposes the Consumer Guarantee Act does not apply.
11. **Confidentiality:** You accept that if you make a warranty claim, Electrolux and its agents including ASC may exchange information in relation to you to enable Electrolux to meet its obligations under this warranty.

Important Notice

Before calling for service, please ensure that the steps listed in clause 8 above have been followed.

SERVICE AUSTRALIA

aeg.com/au

FOR SERVICE

or to find the address of your nearest authorised service centre in Australia

PLEASE CALL 1300 363 664

OR EMAIL

customercare@aegaustralia.com.au

For the cost of a local call (Australia only)

FOR SPARE PARTS

or to find the address of your nearest spare parts centre in Australia

PLEASE CALL 13 13 50

OR EMAIL

customercare@aegaustralia.com.au

For the cost of a local call (Australia only)

SERVICE NEW ZEALAND

aegnewzealand.co.nz

FOR SERVICE

or to find the address of your nearest authorised service centre in New Zealand

PLEASE CALL 0800 234 234

OR EMAIL

customercare@electrolux.co.nz

(New Zealand only)

FOR SPARE PARTS

or to find the address of your nearest spare parts centre in New Zealand

PLEASE CALL 0800 10 66 20

OR EMAIL

customercare@electrolux.co.nz

(New Zealand only)

AEG_Warr_May_17

14. ENVIRONMENTAL CONCERNS

Recycle materials with the symbol . Put the packaging in relevant containers to recycle it. Help protect the environment and human health by recycling waste of electrical and electronic appliances. Do not dispose of

appliances marked with the symbol  with the household waste. Return the product to your local recycling facility or contact your municipal office.

www.aeg.com/au



867358220-C-212022

AEG